

Air Force Institute of Technology

AFIT Scholar

Theses and Dissertations

Student Graduate Works

3-2003

Long Term Implementation of a 100 Percent Checked Baggage Screening System: A Value Focused Thinking Approach

Quincy Meade

Follow this and additional works at: <https://scholar.afit.edu/etd>



Part of the [Systems Engineering Commons](#)

Recommended Citation

Meade, Quincy, "Long Term Implementation of a 100 Percent Checked Baggage Screening System: A Value Focused Thinking Approach" (2003). *Theses and Dissertations*. 4212.

<https://scholar.afit.edu/etd/4212>

This Thesis is brought to you for free and open access by the Student Graduate Works at AFIT Scholar. It has been accepted for inclusion in Theses and Dissertations by an authorized administrator of AFIT Scholar. For more information, please contact richard.mansfield@afit.edu.



LONG TERM IMPLEMENTATION OF A
100 PERCENT BAGGAGE SCREENING SYSTEM:
A VALUE FOCUSED THINKING APPROACH

THESIS

Quincy Meade, Captain, USAF

AFIT/GEE/ENS/03-02

DEPARTMENT OF THE AIR FORCE
AIR UNIVERSITY

AIR FORCE INSTITUTE OF TECHNOLOGY

Wright-Patterson Air Force Base, Ohio

APPROVED FOR PUBLIC RELEASE; DISTRIBUTION UNLIMITED.

The views expressed in this thesis are those of the author and do not reflect the official policy or position of the United States Air Force, Department of Defense, or the United States Government.

AFIT/GEE/ENS/03-02

LONG TERM IMPLEMENTATION OF A
100 PERCENT BAGGAGE SCREENING SYSTEM:
A VALUE FOCUSED THINKING APPROACH

THESIS

Presented to the Faculty

Department of Systems and Engineering Management

Graduate School of Engineering and Management

Air Force Institute of Technology

Air University

Air Education and Training Command

In Partial Fulfillment of the Requirements for the
Degree of Master of Science in Engineering and Environmental Management

Quincy Meade

Captain, USAF

March 2003

APPROVED FOR PUBLIC RELEASE; DISTRIBUTION UNLIMITED

AFIT/GEE/ENS/03-02

LONG TERM IMPLEMENTATION OF A
100 PERCENT BAGGAGE SCREENING SYSTEM:
A VALUE FOCUSED THINKING APPROACH

Quincy Meade
Captain, USAF

Approved:

/s/

Richard F. Deckro, DBA
Co-Advisor

Date

/s/

Stephen P. Chambal, Capt, USAF, Ph.D.
Co-Advisor

Date

/s/

Alfred E. Thal, Jr., Lt Col, USAF, Ph.D.
Reader

Date

Acknowledgements

I would like to express my sincere appreciation to my thesis advisors Dr. Richard Deckro and Captain Stephen Chambal. Both were very generous with their time, encouraging, and always available to offer valuable guidance towards this research endeavor. I would also like to thank Lieutenant Colonel Thal who as a reader for this project provided valuable insight and guidance towards the successful completion of this effort. I would like to thank my sponsor, Mr. Eugene Conrad, the Director of Aviation at Dayton International Airport for not only supporting this effort with his staff but also for encouraging other stakeholders to participate. Mr. Conrad and his staff generously provided many valuable hours and endured several long meetings over the course of some of their busiest months to see this research to its completion. I would like to especially thank Jon Vrabel, Youseff Elzein, and Doug Warner from the Airport Operations staff for dedicating so much of their time and providing valuable expertise used for this study. Last, but by no means least, I would like to thank Ronnie Wayne, Bob Collins, and David Meek for their participation as stakeholders and experts needed to elicit meaningful objectives used in creating this value model. This work could not have been completed without the dedicated work and support of the study team.

Quincy Meade

Table of Contents

	Page
Acknowledgements	iv
List of Figures.....	viii
List of Tables	xi
Abstract.....	xii
Chapter 1. Introduction.....	1
1.1 BACKGROUND	1
1.2 PROBLEM STATEMENT.....	3
1.3 PROBLEM APPROACH.....	4
1.4 RESEARCH SCOPE	5
1.5 OVERVIEW AND FORMAT.....	6
Chapter 2. Literature Review	7
2.1 TRANSPORTATION SECURITY.....	7
2.2 FAA AND TSA RESPONSIBILITIES.....	8
2.3 IMPLEMENTING 100 PERCENT CHECKED BAGGAGE SCREENING.....	9
2.4 DECISION ANALYSIS.....	11
2.4.1 <i>Introduction to Decision Analysis</i>	11
2.4.2 <i>Alternative versus Value Focused Thinking</i>	12
2.5 VALUE FOCUSED THINKING	12
2.5.1 <i>Benefits of VFT</i>	14
2.6 10 STEP PROCESS FOR VFT	15
2.6.1 <i>Step 1: Problem Identification</i>	16
2.6.2 <i>Step 2: Create Value Hierarchy</i>	17
2.6.3 <i>Step 3: Develop Evaluation Measures</i>	18
2.6.4 <i>Step 4: Create Value Functions</i>	19
2.6.5 <i>Step 5: Weight Hierarchy</i>	20
2.6.6 <i>Step 6: Generate Alternatives</i>	22
2.6.7 <i>Step 7: Score Alternatives</i>	22
2.6.8 <i>Step 8: Deterministic Analysis</i>	22
2.6.9 <i>Step 9: Sensitivity Analysis</i>	23
2.6.10 <i>Step 10: Recommendation and Conclusions</i>	23
Chapter 3. Value Model Development.....	24
3.1 STEP 1: PROBLEM IDENTIFICATION	24
3.2 STEP 2: CONSTRUCT VALUE HIERARCHY	25
3.2.1 <i>Decompose Fundamental Objective</i>	29
3.2.2 <i>Passenger Impact Branch</i>	30
3.2.3 <i>Passenger Impact Branch SDVFs</i>	33
3.2.3.1 <i>Visible System</i>	33
3.2.3.2 <i>Distance SDVF</i>	34
3.2.3.3 <i>Number of Times SDVF</i>	34
3.2.3.4 <i>Minutes in Line SDVF</i>	35
3.2.4 <i>Efficient Branch</i>	35
3.2.5 <i>Efficient Branch SDVFs</i>	38
3.2.5.1 <i>Delivery Time SDVF</i>	38
3.2.5.2 <i>Delivery Method SDVF</i>	39
3.2.5.3 <i>Fluctuation of Personnel SDVF</i>	39

	Page
3.2.5.4 Floor Space SDVF	40
3.2.6 Security Branch.....	41
3.2.7 Security Branch SDVFs	44
3.2.7.1 Public Access SDVF	44
3.2.7.2 Catch Rate SDVF.....	45
3.2.7.3 False Alarm Rate SDVF.....	46
3.2.7.4 Isolation Capable SDVF	46
3.2.7.5 Online Performance SDVF	47
3.2.8 Ease of Operation Branch.....	48
3.2.9 Ease of Operation SDVFs.....	49
3.2.9.1 Number of Safety Features SDVF.....	50
3.2.9.2 Number of Comfort Features SDVF	50
3.2.9.3 Time to Repair SDVF	51
3.2.9.4 Number of Breakdowns SDVF	52
3.2.10 Flexibility Branch	52
3.2.11.1 Conveyor Redundancy SDVF.....	54
3.2.11.2 Detection Redundancy SDVF	55
3.2.11.3 Expandable SDVF.....	55
3.2.11.4 Tracking SDVF	56
3.2.11.5 Routing / Divert SDVF	57
3.2.11.6 Sorting SDVF.....	57
3.3.1 Decompose Cost.....	58
3.3.2.1 Personnel SDVF.....	59
3.3.2.2 Level of Construction SDVF.....	60
3.3.2.3 Acquisition SDVF.....	61
3.4 STEP 5: WEIGHT THE HIERARCHY.....	62
3.4.1 Weights for 100 percent checked baggage system	62
3.4.1 Weight Checked Baggage System Hierarchy Local.....	63
3.4.2 Weight Checked Baggage System Hierarchy Global.....	65
3.4.3 Weights for Cost.....	66
3.5 SUMMARY	66
Chapter 4. Data Collection & Analysis of Results	68
4.1 STEP 6 ALTERNATIVE GENERATION	68
4.1.1 Terminal Floor System – Interim as of 31 December 2002	69
4.1.2 Hypothetical System, (Inline System).....	69
4.2 STEP 7 ALTERNATIVE SCORING	69
4.2.1 Checked Baggage System.....	69
4.2.2 Cost Hierarchy.....	70
4.3 STEP 8 DETERMINISTIC ANALYSIS	71
4.3.1 Checked Baggage System Hierarchy	72
4.3.2 Cost Hierarchy.....	72
4.3.3 Cost / Benefit Comparison	73
4.4 STEP 9 SENSITIVITY ANALYSIS	74
4.4.1 Checked Baggage System Hierarchy	75
4.4.2 Cost Hierarchy.....	75
Chapter 5. Findings & Conclusions	78
5.1 OVERVIEW	78
5.2 VALUE MODEL STRENGTHS.....	79
5.3 VALUE MODEL WEAKNESSES.....	79
5.4 CONCLUSION	80
5.5 RECOMMENDATIONS FOR FUTURE WORK.....	80

	Page
Appendix A: Local Weights by Branch	81
Appendix B: Integrated Study Team Minutes	85
Bibliography	104
Vita	107

List of Figures

	Page
Figure 1: Benefits of Value Focused Thinking.....	14
Figure 2: VFT: 10 Step Process.....	16
Figure 3: Buy Best Sports Car Value Hierarchy.....	18
Figure 4: Buy Best Sports Car Value Hierarchy with measures.....	19
Figure 5: Exponential and Piecewise Linear Value Functions.....	20
Figure 6: Exponential Value Function.....	20
Figure 7: Buy Best Sports Car Hierarchy with Weights.....	21
Figure 8: Checked Baggage System Hierarchy.....	28
Figure 9: Passenger Impact Branch.....	31
Figure 10: Passenger Impact Branch with Measures.....	32
Figure 11: Visible System SDVF.....	33
Figure 12: Distance SDVF.....	34
Figure 13: Times Handled SDVF.....	35
Figure 14: Time in Line SDVF.....	35
Figure 15: Efficient Branch.....	36
Figure 16: Efficient Branch with Measures.....	37
Figure 17: Delivery Time SDVF.....	38
Figure 18: Delivery Method SDVF.....	39
Figure 19: Fluctuation of Personnel SDVF.....	40
Figure 20: Floor Space SDVF.....	41

	Page
Figure 21: Security Branch	42
Figure 22: Security Branch with Measures	43
Figure 23: Public Access SDVF	44
Figure 24: Catch Rate SDVF	45
Figure 25: False Alarm Rate SDVF	46
Figure 26: Isolation Capable SDVF	47
Figure 27: Online Performances SDVF	47
Figure 28: Ease of Operation Branch.....	48
Figure 29: Ease of Operation Branch with Measures	49
Figure 30: Number of Safety Features SDVF.....	50
Figure 31: Number of Comfort Features SDVF	51
Figure 32: Time to Repair SDVF.....	51
Figure 33: Number of Breakdowns SDVF	52
Figure 34: Flexibility Branch.....	53
Figure 35: Flexibility Branch With Measures	53
Figure 36: Conveyor Redundancy SDVF	55
Figure 37: Detection Redundancy SDVF	55
Figure 38: Expandable SDVF	56
Figure 39: Tracking SDVF	57
Figure 40: Routing Divert SDVF.....	57
Figure 41: Sorting SDVF	58
Figure 42: Cost Hierarchy with Measures	59

	Page
Figure 43: Personnel SDVF	60
Figure 44: Level of Infrastructure SDVF.....	61
Figure 45: Acquisition SDVF	61
Figure 46: Checked Baggage System Hierarchy	64
Figure 47: Checked Baggage System Hierarchy First Tier Weights.....	65
Figure 48: Cost Hierarchy with Weights	66
Figure 49: Alternative Rankings for Checked Baggage System Hierarchy	72
Figure 50: Alternative Rankings for Cost Hierarchy.....	73
Figure 51: Cost Benefit Plot	74
Figure 52: Passenger Impact Branch Sensitivity Analysis	75
Figure 53: Personnel Sensitivity Analysis	76

List of Tables

	Page
Table 1: Checked Baggage System Affinity Diagram.....	26
Table 2: Passenger Impact Sub-objective Definitions	31
Table 3: Definitions of Passenger Impact Measures.....	32
Table 4: Efficient Sub-objective Definitions	36
Table 5: Definitions of Efficient Measures.....	37
Table 6: Security Sub-objective Definitions.....	42
Table 7: Definitions of Security Measures	43
Table 8: Data for Catch Rate SDVF	45
Table 9: Data for False Alarm Rate SDVF	46
Table 10: Data Points for Online Performance SDVF.....	47
Table 11: Ease of Operation Sub-objective Definitions	48
Table 12: Definitions of Ease of Operation Measures.....	49
Table 13: Flexibility Objective Definitions	53
Table 14: Flexibility Measure Definitions.....	54
Table 15: Cost Objective Definitions	59
Table 16: Cost Objective Definitions	59
Table 17: Checked Baggage System Hierarchy Notional Data.....	70
Table 18: Cost Hierarchy Notional Data	71

Abstract

The terrorist attacks of 11 September 2001, carried out via aircraft hijackings, clearly demonstrated the massive destruction potential when vulnerabilities in the aviation system are exploited. Airport security measures have since been strengthened and new measures have been set in place. With the passage of the Aviation Transportation and Security Act (ATSA) of 2001 the checked baggage systems at U.S. Airports are now required to screen all checked bags with explosive detection devices. This is a significant increase from the small percentage of bags that were previously screened. The original 2009 deadline was changed to 31 December 2002 and this change forced airports to implement interim screening systems. These systems can impact the efficient processing of passengers and baggage. A long term solution is needed for a 100 percent checked baggage system that provides the required security while minimizing negative impacts to aviation stakeholders including the airport operators, airlines, passengers, and the Transportation Security Administration. This thesis, focusing on the Dayton International Airport, uses a Value Focused Thinking methodology to build a value model for evaluating potential long term solutions for 100 percent checked baggage system alternatives.

LONG TERM IMPLEMENTATION OF
A 100 PERCENT BAGGAGE SREENING SYSTEM:
A VALUE FOCUSED THINKING APPROACH

Chapter 1. Introduction

1.1 Background

The aviation system of the United States consists of more than 400 hundred airports and thousands of aircraft serving over 2 million passengers each day (GAO/TCED-00-125:3). Both the U.S. and global economies are dependent upon a reliable and safe means of air transportation. Security for the aviation system in the United States has historically been the responsibility of the Federal Aviation Administration (FAA) which was created in 1958 and became part of the Department of Transportation in 1967.

The very features of the aviation system that allow it to function so effectively make it susceptible to terrorist attacks. Most airports were designed prior to major concerns about security. Airports were designed with large open and generally accessible areas. Each airport is unique in its layout, number of airline carriers, and other stakeholders. Airports, and their associated support facilities, are scattered throughout the nation. The dispersed nature of our aviation system makes it difficult to secure all possible vulnerabilities. Airports were designed for efficient and cost effective travel. Security measures often add time to travel and make the travel system less efficient. In addition, public airports are owned and operated by diverse state and local governments. Airports are integrated parts of the economy in many cities, with communities relying on them to bring in business travelers and tourists.

Airports continue to be vulnerable targets. The introduction of new and improved security measures has unfortunately been mainly reactive to the type of terrorist event that occurred and mitigated the exploited vulnerability. One such security measure is the screening of passengers, as well as their carry on and checked bags, for weapons and explosives (NMAB 482-3:1998: v).

On 21 December 1988, Pan American Flight 103 exploded over Lockerbie Scotland as a result of an explosive device hidden inside a suitcase. In response to this terrorist act, the U.S. enacted the Aviation Security Improvement Act of 1990. Through this act the Federal Aviation Administration (FAA) began funding the development of Explosive Detection System (EDS) technology to be used to screen checked baggage. The FAA continued to expand its EDS technology purchases and certifications (NMAB 482-3:1998: v). In 1994, the FAA approved the first EDS system, Invision CTX 5000, for use at U.S. Airports. The international aviation community also responded to the Pan American Flight tragedy with the use of EDS technology. The United Kingdom began to install EDS machines for airport checked baggage systems in 1990. By 1998, all commercial airports in the U.K. had 100 percent screening of checked baggage. The target date goal within the U.S. for 100 percent screening originally established by the FAA was 2009. However, recent events changed that time horizon.

On 11 Sept 2001, terrorists demonstrated how our transportation system could be used as a means to carry out new acts of destruction, literally making weapons out of passenger aircraft. These acts highlighted weaknesses within the aviation transportation system. These weaknesses include the limited capabilities of airport security to screen all potential terrorists and their weapons from boarding aircraft. These acts also increased

public awareness to the fact that not all checked baggage was being screened for explosives.

The Transportation Security Administration (TSA) was established with the Aviation and Transportation Security Act of Nov 19, 2001(Public Law 107-71). This law assigned the responsibility of aviation security to the TSA. This act also included several security mandates with implementation deadlines. One of the mandates was the requirement to have 100 percent of checked bags screened with EDS technology by the end of 31 December 2002. The short timeframe (19 November 2001 to 31 December 2002) given to the newly formed TSA and airports to meet the mandate of 100 percent baggage screening forced the implementation of interim systems, without the time and resources necessary to fully accommodate all potential concerns of the stakeholders impacted by the system. These concerns would have normally been captured during the lengthier design process that was anticipated by the FAA's earlier stated 2009 deadline. To satisfy the 31 December 2002 mandate, some airports installed large, heavy EDS machines in the airport lobbies, impacting lobby floor space due to the sizable EDS machines and additional queuing lines necessary for passengers to hand carry their checked bags to these screening machines. With the mandate met and the immediate threat mitigated, there is now time to consider additional relevant issues and objectives involved with selecting a long term solution for a 100 percent checked baggage system.

1.2 Problem Statement

The objective of this study is to assist the stakeholders of the aviation system with the long term implementation of the 100 percent checked baggage screening. While

every effort was made to consider all relevant factors while meeting this mandate, not all concerns were articulated and considered in the reduced implementation timeline. Using a decision analysis methodology known as Value Focused Thinking (VFT), the values important to a long term solution of a checked baggage system can be captured in a value hierarchy model. VFT is a process for capturing **values** that can be used to create alternatives to decision problems as well as evaluate how well different alternatives meet the expressed values. (Keeney, 1997:3)

Airport security involves many stakeholders including the passengers, airlines, airports, the FAA, the TSA, and public communities. The level of security to be provided must be balanced against the effect that a security level will have on the efficiency of operations, that which will be tolerated by the passengers, and that which the government, (local, state, regional, and federal), airports, and airlines can afford to implement. The VFT methodology assists in the evaluation and balancing of these values for various competing objectives as well as capturing their importance to the decision-maker into a value hierarchy model.

1.3 Problem Approach

Airport security depends on an evolving science with new technologies and systems constantly being introduced and tested. Dayton International Airport, as well as all other commercial airports across the country, has implemented a 100 percent baggage checking system. The checked baggage system in place at Dayton International Airport is an interim solution. EDS and explosive trace detection machines (ETD) were placed in the airport lobby in front of airline check in counters. Passengers hand carry their bags to

the screening machines after checking in with the airlines. Once the bags are cleared in the passenger's presence, the bags are left with the TSA personnel and then transferred to the airlines. Meanwhile, the passengers move to the passenger screening area and departure gates.

The long term solution for the checked baggage system includes multiple objectives such as the prevention of incidents that could harm passengers, maintaining an efficient flow of passengers, and the public acceptance of security measures. Focusing on what objectives are valuable for a long term solution will lead to the creation of a value hierarchy that captures the value of checked baggage systems. This value driven approach can also lead to the development of alternatives that were not previously foreseen.

1.4 Research Scope

The decision perspective for this thesis is from that of the Dayton International Airport's Director of Aviation as well as the airport's stakeholders (Airlines, TSA, and Passengers). The focus of this research provides support to the personnel responsible for managing and implementing a 100 percent checked baggage system as well as those stakeholders affected by the system. Tangible benefits from this study are applicable to other airports, as they face the same challenges. This study does not address specific airport security vulnerabilities or measures that would require this document to be classified.

1.5 Overview and Format

This thesis is organized into five chapters. A literature review of airport security law, regulations for checked baggage, as well as an introduction into VFT is provided in Chapter 2. A presentation of the value of checked baggage system, how this value is measured using VFT, and how it can be applied to decision makers in the area of airport security is provided in Chapter 3. A demonstration of this value model using two notional alternatives is provided in Chapter 4. Conclusions from this study, as well as recommendations for further research, are provided in Chapter 5.

Chapter 2. Literature Review

This chapter provides a review of the pertinent literature in the field of airport security and decision analysis. This includes the laws and regulations that assign responsibility and direct the implementation of airport security to various stakeholders. The decision analysis method of Value Focused Thinking (VFT) is also reviewed. A description of how this method can benefit airport security is also provided.

2.1 Transportation Security

The medium of transportation involves moving people, goods, and services around the nation and the globe via highway, rail, waterways, and air. Terrorists exploited the vulnerabilities of the aviation system on 11 September 2001, turning jet airliners into guided missiles. The Transportation Research Board suggests the following characteristics of transportations systems make them vulnerable targets for future terrorist attacks (TRB Special Report 270, 2002:1-3).

1. Openness and Accessibility – Most of the transportation system was built prior to concern with terrorism and must be accessible to the public
2. Extent and Ubiquity – There are over 400 commercial airports and 14,000 general aviation airports dispersed across the country
3. Efficiency and Competitiveness – The various modes of transportation require maximum efficiency to allow for competition between them.
4. Owner, Overseer, and Operator Diversity – The public sector owns and operates much of the transportation infrastructure such as airports and railroads.
5. Entwinement in Society and Global Economy – highways, railways, airways, and waterways connect small towns and major cities across

the nation and support the economy through tourism, mail delivery, daily commuting travel, and the delivery of products and services

These very features, which support the efficiency and effectiveness of the nation's transportation system, leave it vulnerable to exploitation.

2.2 FAA and TSA RESPONSIBILITIES

The Federal Aviation Administration (FAA) was created in 1958 to be responsible for a safe aviation system. The FAA is a principal government organization responsible for regulating the design and operating standards of airports. One of the FAA's objectives is to reduce vulnerabilities of the air travel system to terrorist threats. This was accomplished with procedures and supporting technologies to detect, deter, and react to these threats before they can cause harm. In response to the bombing of Pan American Flight 103 the FAA issued a directive to purchase technology capable of detecting explosives in checked bags. The most advanced technology available at that time was Thermal Neutron Analysis (TNA) machines. After testing, the FAA discovered that the TNA machines were not capable of detecting explosives at low enough levels necessary to detect all critical quantities of explosives, such as the amount of explosive believed to have been used on Pan Am Flight 103. The FAA continued making efforts towards other detection systems. The FAA began testing of EDS machines in 1990 and developed classified certification criteria in 1993. These criteria include standards for various types of explosives, baggage throughput rates, and acceptable rates for false alarm and detection (GAO/RCED 97-119, 1997:3). The first approved EDS system received FAA certification in 1994; it was the INVISON CTX-5000. The FAA then

began deploying EDS machines at select airports over the course of the next several years.

The Aviation Security Improvement Act of 2000 required the FAA to gradually increase the number of checked bags being screened by EDS machines to reach 100 percent screening of checked baggage by 2009. The terrorist acts of 11 September 2001 led to passing of the Air Transportation and Security Act (ATSA) of 2001. This act created the Transportation Security Administration (TSA) and gave this organization the responsibility for security in all modes of transportation.

The TSA took over primary responsibility for aviation security on 17 February 2002. The ATSA of 2001 mandated that 100 percent of checked baggage be screened with EDS machines by 31 December 2002. This new date required the deployment of these large, heavy EDS machines to 429 commercial airports with little time to consider how they would effect processing of passengers and their bags. Many airports were not designed with the necessary floor space required to accommodate these machines or with the space needed to adequately integrate them into baggage handling systems. The TSA, along with the various airports and airlines were forced to implement the best alternative attainable within the short timeframe.

2.3 Implementing 100 Percent Checked Baggage Screening

A white paper prepared by RAND examined the FAA plans for implementation of the EDS machines to meet the 31 December 02. This study identified several problems with the implementing the deployment schedule. One of these problems reinforces the need for an airport level study.

The FAA's "top-down" approach does not adequately consider local constraints, such as the size of the airport terminal. It is space constraints, not machine availability that is the proverbial long pole in the tent. Until suitable airport facilities are constructed, many of the EDS machines now being acquired at a highly accelerated rate cannot be installed (Kauvar, Rostker, and Shaver, 2002:4)

Whether new facilities are built or existing facilities are modified, the objectives of the stakeholders affected by 100 percent checked baggage screening should be identified.

These objectives can then be incorporated into the decision making process for selection of the system most suited for a particular airport.

Dayton International Airport, as with airports around the country, has interim measures in place to satisfy the 100 percent screening requirement. The long term solutions to satisfy the requirement while meeting the objectives of the airports, airlines, and TSA have yet to be resolved. A report prepared by the FAA provided the following planning considerations for future checked baggage screening (Lazarick and Cammaroto, 2001:92). 1

1. Adequate space allocation for equipment
2. Queuing space
3. Adequate power sources
4. Communications and environmental equipment
5. Adequate floor loading
6. Appropriate facilities where passengers and their baggage can be reunited for the purpose of alarm resolution

Other considerations include a system that will provide convenience to the passenger, maximize the throughput of bags, minimize the impact on airline personnel, and

maximize the effectiveness of security. The Dayton International Airport must implement a long term solution that will best satisfy the objectives for security while not losing focus on the fact that the airport is a business and the passengers are the customers who have objectives to be included as well. It is the stakeholders at the airport level that will best provide the objectives and considerations most important in a 100 percent checked baggage system.

2.4 Decision Analysis

Determining which checked baggage system alternative is best suited to meet the objectives of the Dayton International Airport stakeholders is a complex problem. There are several different alternatives available to the airport. Each alternative has its pros and cons, and each satisfies the various objectives differently. These objectives include: How does the system impact passenger convenience? Will the system require more manpower from the airport and airlines than the current system? Will the system require more terminal floor space or construction of new facilities? There are a number of checked baggage system alternatives and numerous objectives that each alternative should be evaluated against. A multi-objective decision analysis technique can provide the methodology necessary to clearly layout this problem. Decision analysis can be used to handle problems with several variables and objectives that would otherwise be too complicated and confusing.

2.4.1 Introduction to Decision Analysis

Decision Analysis (DA) is a “prescriptive approach designed for normally intelligent people who want to think hard and systematically about some important real

problems” (Keeney and Raiffa, 1976: vii). Decision Analysis allows problems to be evaluated with an assortment of structures such as decision trees, influence diagrams, and value hierarchies (Clemen, 1996:2). Through decision analysis the decision maker is able to better structure complex decisions, gain additional insight to the problem, and consider the trade offs between multiple objectives.

2.4.2 Alternative versus Value Focused Thinking

The standard approach to decision making is alternative focused thinking. This is the process of reviewing the existing alternatives in search of the best one. Decision makers limit themselves through Alternative Focused Thinking. It is possible that not one currently available alternative is best suited for the decision maker. Value Focused Thinking (VFT) is an approach that relies on the values important to the decision maker (Keeney, 1992:6). These values are used to structure a value model that can be used to generate the best alternative. The VFT approach requires the decision maker to answer the questions about what is of value with regard to the decision to be made.

2.5 Value Focused Thinking

Decision analysis and VFT have been used to successfully assist decision makers in several different private, public, and government organizations. Keefer, Corner, and Kirkwood (2000) performed a literature review of the major operations research journals from 1990 to 1999. Their review included articles and texts that used decision analysis methods as well. The review included 57 application articles grouped into Energy, Services and Manufacturing, Medical, Military, Public Policy, and General categories. Their literature review highlights the fact that decision analysis and VFT have been

applied in a wide variety of fields. Two such examples are outlined in the next few paragraphs.

VFT was used to “examine the concepts, capabilities, and technologies the United States will require to remain the dominant air and space force in the future (Jackson, Jones, and Lehmkul, 1996:iii). In 1995, General Ronald R. Fogleman, the Air Force Chief of Staff, tasked Air University to “generate ideas and concepts on the capabilities the United States will require to possess the dominant air and space forces in the future”. This study, entitled Air Force 2025, and an accompanying value model was developed using the VFT methodology to select the best systems and technologies for the Air Force given alternative futures (Jackson, Jones, and Lehmkul, 1996). The value model created was very robust; it included 134 force qualities, each with a measure of merit and value function. A value model with this detail can be used to evaluate a diverse set of systems. This model was also used to forecast decisions further in the future than any known military value model (Jackson, Jones, and Lehmkul, 1996:14).

VFT was also used in a study to assist action officers at the Air Force Force Protection Battlelab in their evaluation method used for potential force protection initiatives. The VFT process enabled the action officers to create a value model quantifying the objectives important to the Air Force. Previously, the Battlelab relied on the skills of the action officers to present and defend their interpretation of proposed initiatives rather than comparing each initiative based on an equivalent set of merits and the relative benefit of each proposed initiative (Jurk, 2002).

Clearly, VFT has been used to assist in a number of complex decision environments.

2.5.1 Benefits of VFT

The following figure from Keeney's text provides an overview of how VFT can benefit the decision making process.

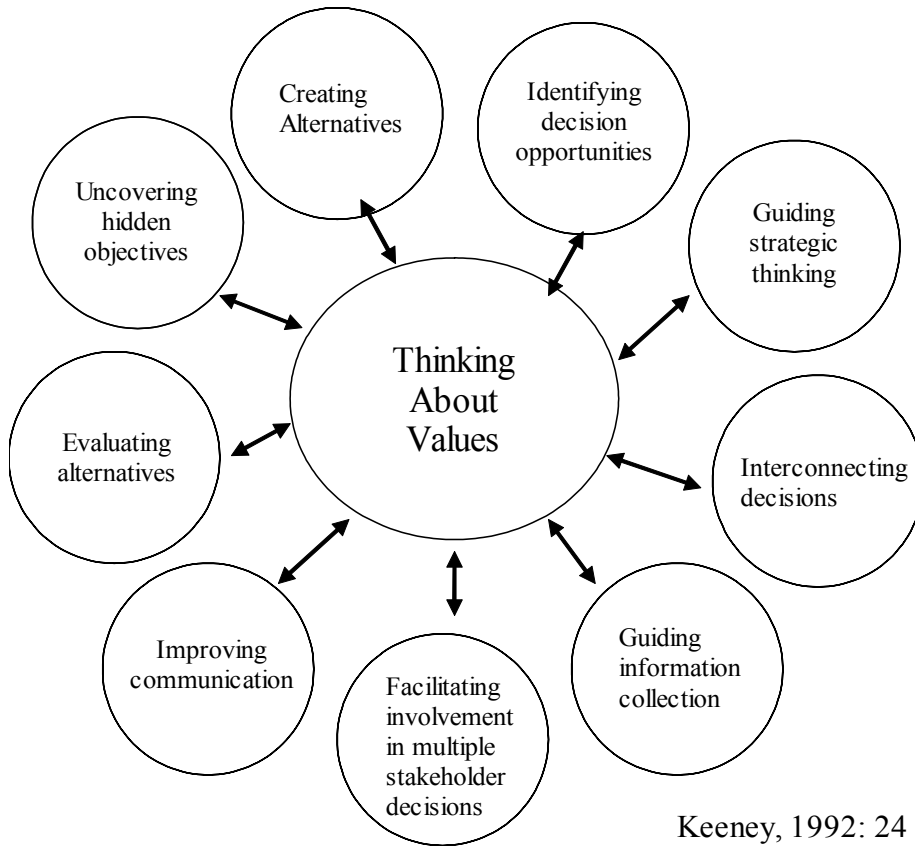

Figure 1: Benefits of Value Focused Thinking

“The language of value-focused thinking is the common language about the achievement of objectives in any particular decision context” (Keeney 1997:25). As a result, the participants in this type of problem solving are not limited to those with technical expertise and the identification of objectives can be made with a greater amount of understanding. By using the language of values rather than alternatives, stakeholders can focus on the conflicts that may arise within these values rather than conflicts in which alternative they personally believe to be the best.

2.6 10 Step Process for VFT

The VFT methodology allows decision makers to obtain a value model which includes everything important to the decision maker. The process can be divided into 10 steps which are provided in the Figure 2 (Shoviak, 2001: 63). Shoviak developed this framework in part based on the work of Keeney (1992), Kirkwood (1997), and Kloeber (2000) who examine the use of Value Focused Thinking in decisions with multiple objectives. These steps are not sequential but and are meant to be performed in an interactive manner. These 10 steps for VFT will be used as the methodology framework for conducting this study.

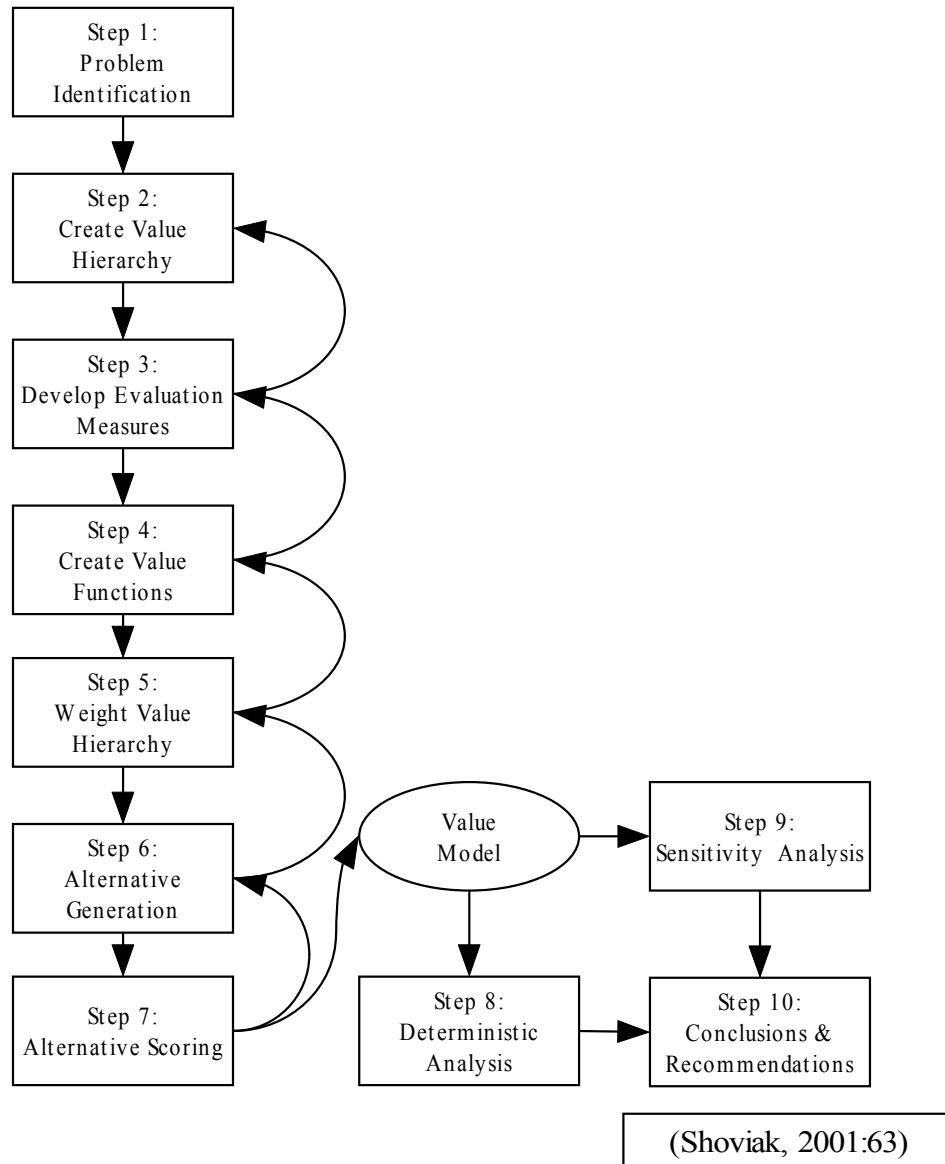

Figure 2: VFT: 10 Step Process

2.6.1 Step 1: Problem Identification

During this first step the decision maker should ask “What is the fundamental issue?” Identifying the overall objective of the problem clearly during this step will ensure the rest of the steps can be used effectively in order to solve the problem in the

best manner. As an example, consider a fundamental objective of choosing the best sports car. This example will be used to assist in illustrating the VFT methodology.

A poorly defined problem will most likely lead to an unwanted or useless value model.

2.6.2 Step 2: Create Value Hierarchy

A value hierarchy begins with a fundamental objective as defined in Step 1. The fundamental objective is then decomposed into sub-objectives which provide more detail. Each sub-objective is expanded until it can be defined by a single attribute.

There are five desirable properties of a value hierarchy; small size, operability, completeness, non-redundancy, and decomposability. (Kirkwood, 1997:16). The small size is important because that helps in the ease of understanding. A very large hierarchy with hundreds of objectives can be too difficult to understand. The small size property leads into the operable property. This methodology is used to assist decision makers and therefore it should be able to do just that. A model that is not easy to use or understand is often not operable. The completeness property describes the need for the hierarchy to provide enough detail so that key features of the fundamental objective are discernable and the differences in these features are captured by the hierarchy. The completeness property is often referred to as collectively exhaustive. The non-redundancy property describes the need to have a hierarchy that does not include more than one objective that describes the same feature. This is also referred to as mutual exclusivity.

Continuing with the “Buy the Best Sports Car” example, Figure 3 illustrates a hierarchy starting with the fundamental objective of buying the best sports car. The fundamental objective is decomposed into three sub-objectives which are functionality,

performance, and safety. These sub-objectives are decomposed one more time until the sub-objectives are reached that can be measured.

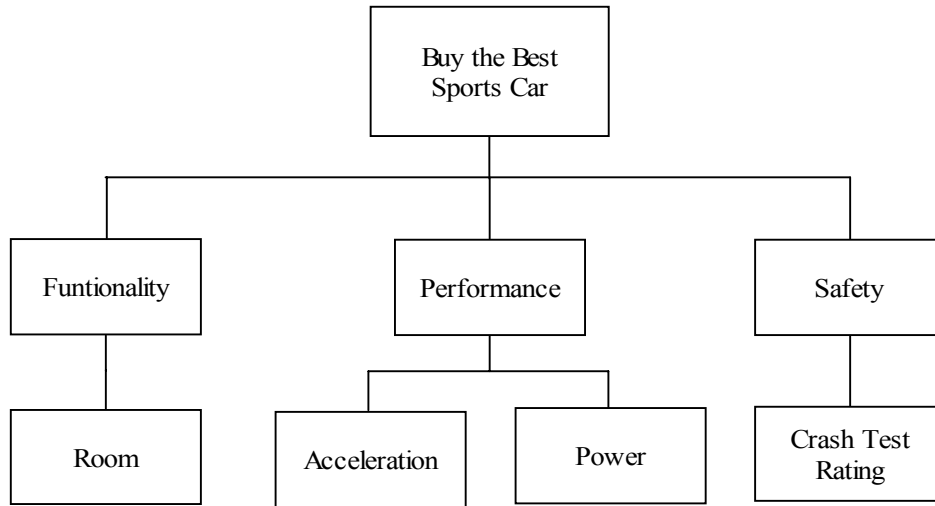

Figure 3: Buy Best Sports Car Value Hierarchy

2.6.3 Step 3: Develop Evaluation Measures

For this step measures are assigned to each of the lowest level sub-objectives. Measures have scales which are either natural or constructed and direct or proxy. A Natural scale is one that is already accepted by most people. An example is miles per gallon which is commonly used for vehicle fuel efficiency. A constructed scale is created for a specific decision to quantify how well a sub-objective is met. “A direct scale measures the degree of attainment of an objective, while a proxy scale reflects the degree of attainment of its associated objective, but does not directly measure this”(Kirkwood, 1997:24). A direct scale can provide a direct measurement for how well a sub-objective is satisfied. The miles per gallon measure is also an example of a measure with a direct scale. A proxy scale provides a representation for how well a sub-objective is satisfied. An example of a direct scale is human age in years. An example of a proxy scale is the gross national product (GNP) which is often used to describe the development of a

country (Kirkwood, 1997:24). Continuing with the “Buy the Best Sports Car” example, measures for each of the lowest tier sub-objectives are shown on the bottom level of the hierarchy in Figure 4. In this example there are two measures for the **Room** sub-objective. These measures are the number of seats and the leg room. The upper and lower bounds for the scales are then developed for each measure that captures the range of feasible data. For the *Number of Seats* measure, the upper and lower bounds are 5 and 2 respectively, for example.

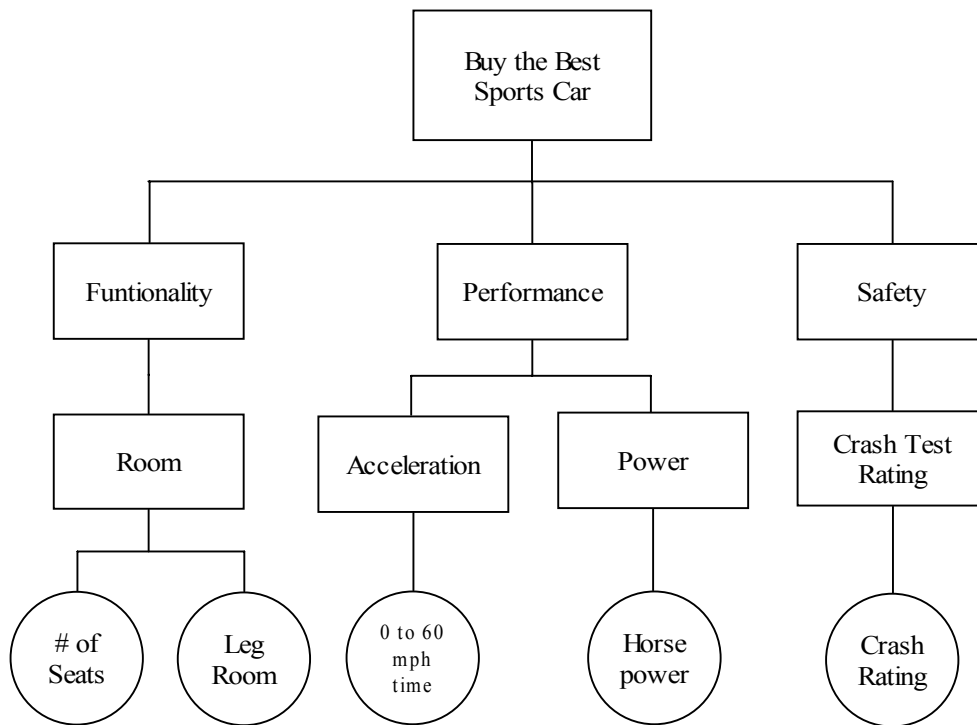

Figure 4: Buy Best Sports Car Value Hierarchy with measures

2.6.4 Step 4: Create Value Functions

Value Functions are used to assign a value from 0 to 1 to data for each measure for each alternative. These value functions are single dimensional and are either monotonically increasing or decreasing functions. Two common types of value functions

are the exponential and piecewise linear. An example of an exponential and piecewise value functions are provided in Figure 5. Both of these functions are monotonically increasing. The functions increase in value on the Y-axis as the score increases on the x-axis. The piecewise linear function has two different slopes that convert the x-axis score to a y-axis value. An exponential value function that is monotonically decreasing is provided in Figure 6.

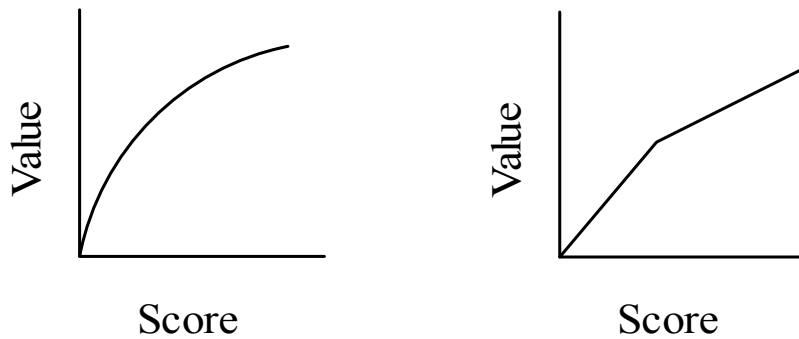

Figure 5: Exponential and Piecewise Linear Value Functions

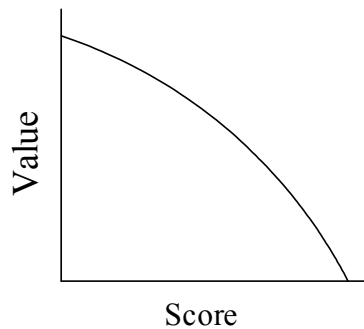

Figure 6: Exponential Value Function

2.6.5 Step 5: Weight Hierarchy

The decision maker is unlikely to value each objective of the value hierarchy equally. Therefore, the decision maker will need to assign a weight to each objective to represent the importance of each. The “100 marble method” was used for this study. The decision maker has 100 imaginary marbles to assign to each objective within each branch

of each tier of the hierarchy. The number of marbles assigned represents the relative preference of the objectives. The 100 marbles are notional, and are used to assist the decision maker in assigning direct weights to the hierarchy.

The example hierarchy for the Buy Best Sports Car example has been given weights as shown in Figure 7. Using the 100 marble method the decision maker for this problem gave both functionality and safety 20 marbles each and performance 60 marbles. The marbles are then divided by 100 so that the total of the weight sums to 1. The same method is applied for the next tier. Functionality and Safety have one sub-objective each so they receive 100 marbles and the corresponding weight is 1.0. The performance objective has two sub-objectives, acceleration and power. The acceleration and power sub-objectives were given 60 and 40 marbles respectively. Their corresponding weights are therefore .60 and .40.

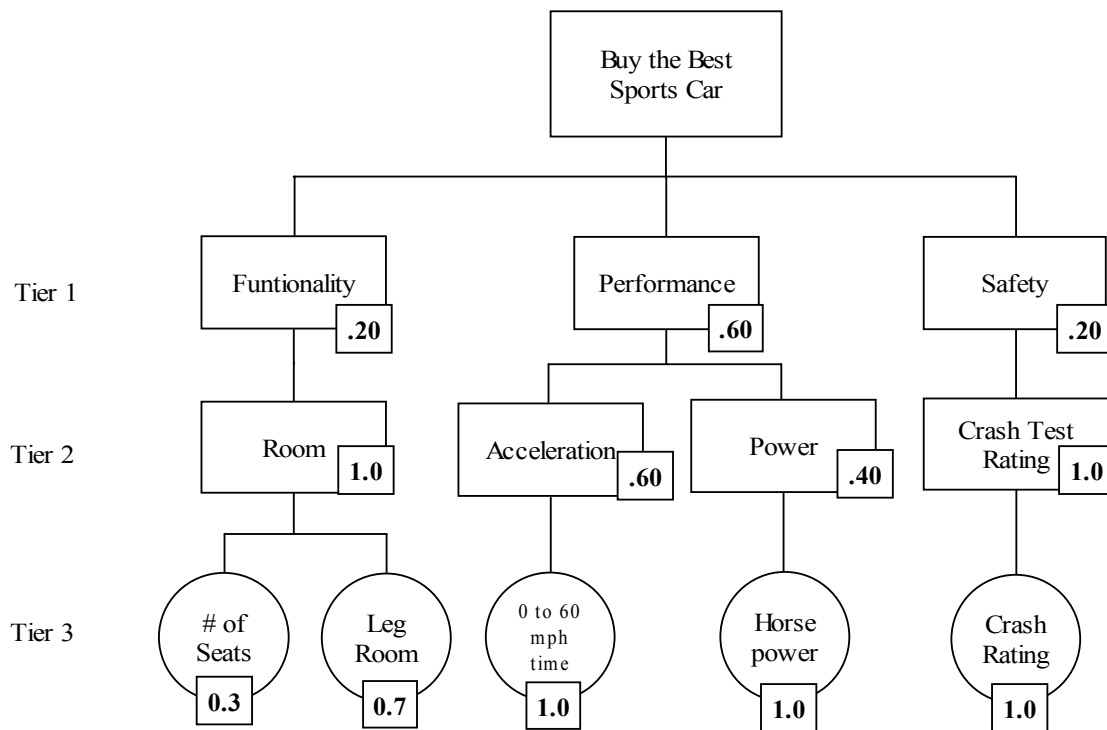

Figure 7: Buy Best Sports Car Hierarchy with Weights

2.6.6 Step 6: Generate Alternatives

Alternatives that appear to satisfy the objectives of the value hierarchy developed in Step 2 can be used along with existing alternatives to be evaluated and compared in later steps.

2.6.7 Step 7: Score Alternatives

Data for each of the measures developed in Step 3 are now needed for each of the alternatives generated in the previous Step. Each alternative is scored based on the SDVF for each measure. The score for each measure of the hierarchy should be determined for all of the alternatives before moving to the next measure. Scoring is done from specific data for natural direct measures to subject matter experts' opinion for less quantitative measures.

2.6.8 Step 8: Deterministic Analysis

In this study a decision analysis software package, Logical Decisions for Windows, was used to input the information and data from the previous steps. Once the data for each measure was input on all of the alternatives an overall value for can be computed for each alternative.

The overall value for the alternatives is computed using the additive value function. This function uses the SDVF and weights assigned to each measure to create an overall score for a given alternative.

$$v(x) = \sum_{i=1}^n \lambda_i v_i(x_i)$$

$V(x)$ is the total value for an alternative, λ_i is the weight for each measure from i to n , and $v_i(x_i)$ is the score each measure attains from its value function (Kirkwood, 1997, 230).

2.6.9 Step 9: Sensitivity Analysis

Sensitivity Analysis is performed to examine how a change in the assigned weights will affect the overall value scores for the alternatives. This is done by varying the weights of an objective from 0 to 1 while maintaining the original proportion of the weight with the other objectives. This can be done at any tier of the hierarchy. This step provides valuable insight to the decision maker. It highlights the objectives that with a realistic change in weighting, effect which alternative receives the highest score. It can also show the insignificance of the weight given to an objective, provided that with any reasonable change of it's weighting, makes no difference to the alternative rankings. Such analysis helps to focus weighting efforts on those objectives where a reasonable change may alter the decision.

2.6.10 Step 10: Recommendation and Conclusions

Insight gained from the VFT process is now provided to the decision maker to include how each alternative ranks and how the alternative scores can be improved with the identification of value gaps. Once the decision maker has been presented with the results the value hierarchy can be used again in an iterative method of generating and evaluating future alternatives for the same problem.

Chapter 2 has provided the basic background required to execute this study. Chapter 3 will detail the application of VFT approach to the Dayton International Airports 100 percent checked baggage decision environment.

Chapter 3. Value Model Development

Chapter 3 develops the value model built for the Dayton International Airport. The chapter follows the ten step process discussed in Chapter 2 and presents the elements of the model.

3.1 Step 1: Problem Identification

The fundamental objective of this study is to capture the values important in a 100 percent checked baggage system at the Dayton International Airport. The system includes the screening machines, conveyor system, and personnel responsible for screening and handling the checked bags. Specifically, the system of study starts from the point where a checked bag is given a flight identification tag at the airline check-in counters and ends at the point the bag arrives at the airline make up room. The make up rooms are where the bags are delivered to the airline baggage handlers. The custody of the bags is transferred from TSA to the airlines at this point. Once delivered to the respective make up rooms the screening of the bags has been completed and the airline personnel can organize and prepare to load them on their planes.

The decision maker for this problem is the Director of Aviation at Dayton International Airport. The Director of Aviation is concerned with operating a safe airport that provides an efficient flow of passengers. Several stakeholders are involved in the operation of an airport and are impacted by a checked baggage screening system. To gain insight and concerns from these stakeholders an integrated study team was formed consisting of members of the Director of Aviation's staff, the TSA Head of baggage screening managers and two airline managers from major airlines servicing Dayton

International Airport. The study team was used throughout the model development to elicit values and construct measures.

3.2 Step 2: Construct Value Hierarchy

For this step, the study team provided the objectives they believed to be important to the fundamental objective. This process consisted of a series of six group sessions. The study group started the hierarchy development by creating an affinity diagram for the checked baggage system. Each stakeholder provided what they believed to be the most important considerations for the system. These items were listed individually until all concerns were captured and recorded. The items were then combined into common groups. A total of fifty items of value were grouped under five main headings which are Passenger Impact, Efficient, Security, Reliability (which evolved to “Ease of Operation”), and Flexibility. The results from the affinity diagram are provided in Table 1.

Table 1: Checked Baggage System Affinity Diagram

Passenger Impact	Efficient	Security	Reliability (Ease of Operation)	Flexibility
Clarity of Use	Bottlenecks, logistics	Security of equipment	Reliability, maintainability, availability	Impact on airline staff
# times handling bags	Flow efficiency / congestion at end of system	Vulnerability	Safety	Work within environment
Visibility of bags	Impact on airline staff	Visibility of equipment	Exposure to radiation	re-routing
Customer Hassle	# times handling bags	Alarm resolution	Comfort of screeners	Back-up
-Queues	Efficient, throughput	Isolation capability of major hit / security breach	Environment of screeners	technology
-lines	Automated kick off for flagged bag			Shut down procedures
Passenger confidence	Uninterrupted flow			Upgradeable
Passenger convenience	Space utilization			Expandable
Visibility of security	Different run speeds			Scalability - operationally
Integrated with checkpoint	Reaction to first hit			
	Flow assurance - bags to right place			

These common headings became the initial first tier of the hierarchy. Over the course of the next several meetings these 1st tier objectives were refined into sub-objectives.

During the affinity diagram process the group also identified cost related items. The cost items were treated separately and used to form a cost hierarchy. The intent was to create a cost to benefit comparison between the overall cost given by the cost hierarchy

and the benefit captured by the checked baggage system hierarchy. The benefits and costs of each approach would then be analyzed. The cost hierarchy is discussed after the 100 percent checked baggage hierarchy. The complete hierarchy for the 100 percent checked baggage system is provided in Figure 8 to illustrate the size and extent of the model.

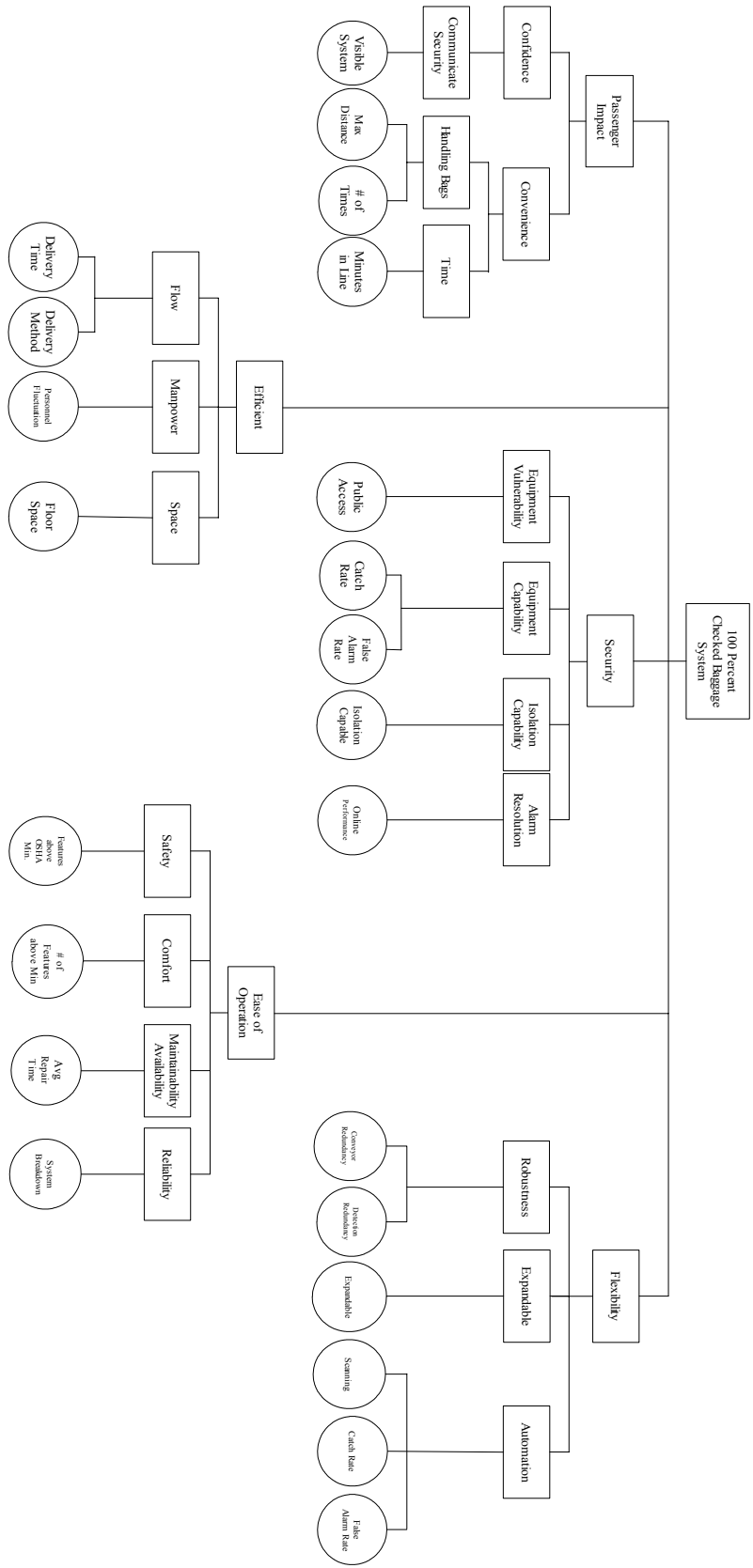

Figure 8: Checked Baggage System Hierarchy

The five first tier objectives of the checked baggage system hierarchy, starting from the left and moving right are Passenger Impact, Efficient, Security, Ease of Operation, and Flexibility. Each first tier objective and corresponding sub-objectives is referred to as a branch. The objectives within this model are discussed in detail beginning with the fundamental objective and then by branch, starting with the Passenger Impact branch and moving to the right of the hierarchy. The discussion of each branch includes the development of evaluation measures and value functions. The evaluation measures are used for the lowest tier objectives to determine how an alternative meets the objectives. The value functions convert actual data for each measure (x-axis) to a value (y-axis). The y-axis value ranges from 0 to 1. A value of 0 represents the least desirable data for a measure while a value of 1.0 represents the most desirable data.

3.2.1 Decompose Fundamental Objective

The main objective of this checked baggage system hierarchy to provide the best long term solution to a 100 percent checked baggage system for the Dayton International Airport. The system will include detection equipment such as Explosive Trace Detection (ETD) systems, EDS machines, conveyor systems, and operators necessary to run the system. The approved explosive screening equipment used for any alternative must be certified by the FAA as meeting minimum performance standards. Additionally, the TSA must approve the equipment to be used at Dayton International Airport. There are a limited number of manufacturers of explosive detection machines that have been approved for use in airports. The TSA, who currently selects and pays for the EDS

equipment, has final approval. The hierarchy includes objectives that can be used to differentiate and recommend using a specific manufacturer's equipment.

3.2.2 Passenger Impact Branch

The Passenger Impact branch includes items derived from the affinity diagram process that represent the 'hassle factor' for passengers. The hassle factor is the amount of inconvenience the passenger perceives as a result of the checked baggage system. While the study group did not include a passenger representative, all members relied on their own experiences as passengers, as well as the airport operators and airlines expertise in dealing with passengers, to develop objectives for this branch.

The convenience objectives were broken down into the handling of bags and the time needed of the passenger to complete bag screening. The passenger impact branch included an objective for the confidence the passengers have that the system is providing effective security, both in the inspection of the baggage for explosives and in the protection of their property. The study group believes that this perception is positive when passengers can see that a screening process is taking place. Figure 9 illustrates the sub-objectives that were developed for the Passenger Impact branch of the checked baggage system hierarchy.

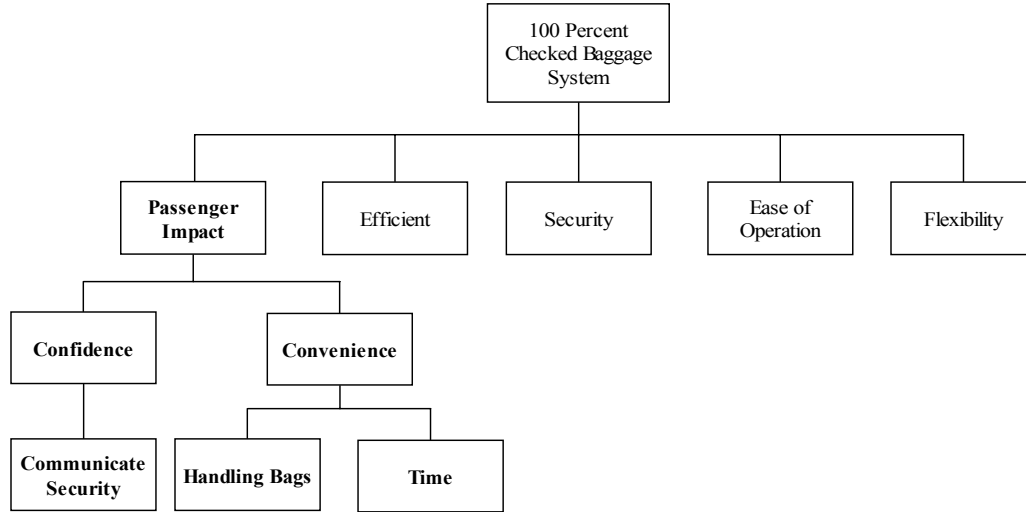

Figure 9: Passenger Impact Branch

An important part of the hierarchy development is clearly defining the meaning of the objectives. The definitions used for the Passenger Impact Branch objectives and sub-objectives are provided in Table 2. The next step for this branch was to define measures for each of the lowest tier objectives that can be used to determine how well each objective is attained by a 100 percent checked baggage system.

Table 2: Passenger Impact Sub-objective Definitions

Passenger Impact	Confidence the passenger has that the baggage screening system is providing security and the convenience provided while doing so.
Confidence	Trust the passengers has that the screening system is protecting him/her from danger
Communicate Security	Providing information about the security screening system through any means such as CCTV, windows, or other display devices
Convenience	Minimizing the work and time required from the passenger
Handling Bags	The effort required from the passenger to clear his/her checked bags
Time	The time required from the passenger to clear his/her checked bags

Measures were developed for each of the lowest tier sub-objectives. These measures have been added to the Passenger Impact branch and are displayed below the lowest tier sub-objectives for this branch in Figure 10.

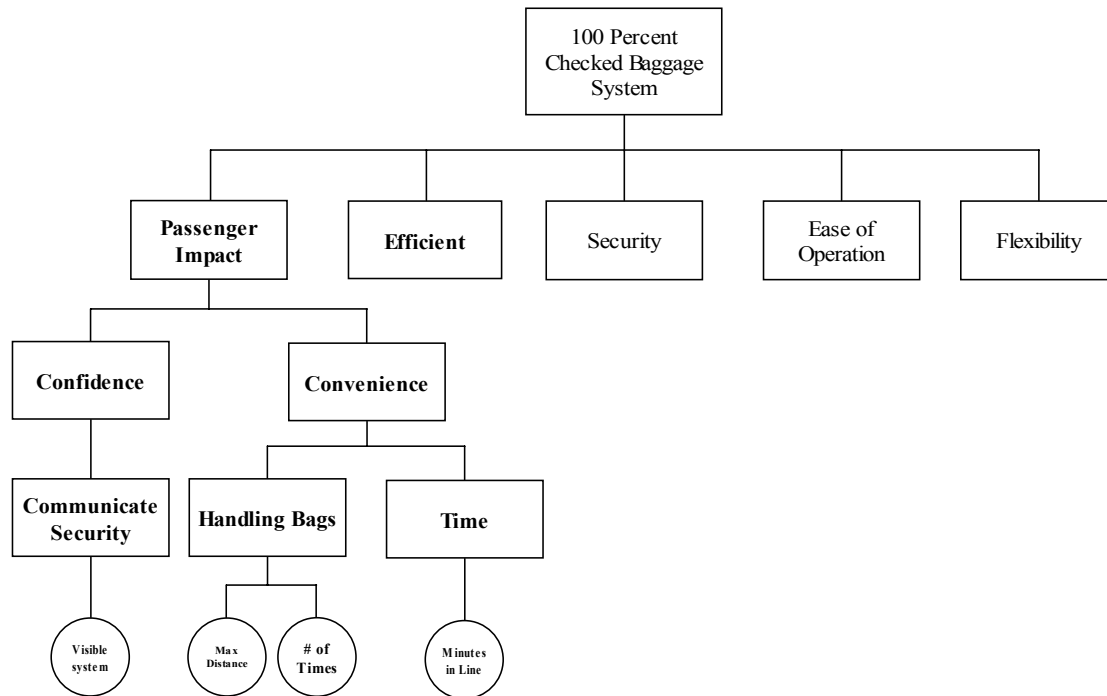

Figure 10: Passenger Impact Branch with Measures

A summary of the measure definitions for the Passenger Impact branch are provided in Table 3. The next step for this Branch is to define value functions.

Table 3: Definitions of Passenger Impact Measures

Measure	Definition
Visible System	A system that can be seen by the passengers
Distance (feet)	The distance that the passenger has to move checked bag in screening process
Times Handled	The number of times the passenger has to move checked bag from one screening station to another before screeners take custody of the bag.
Time in Line (minutes)	The time the passenger is required to wait while the checked bag is being screened.

3.2.3 Passenger Impact Branch SDVFs

The Passenger Impact branch consists of four measures; single dimension value functions (SDVF) were developed for each by the study group. A brief discussion of each value function is provided separately.

3.2.3.1 Visible System

A system that can be seen by the passenger allows the passengers to see that the bags are being screened for potential threats. As stated earlier, it is preferred to have a checked baggage system that is visible. This visibility can be provided by means such as a closed circuit television, window to screening operation area, or a display system illustrating the routing of the bags to screening machines. The study group believes that passengers will have confidence in a visible system. This SDVF is categorical in that the system either is visible or not. A visible system receives a value of 1.0. A system that is not visible receives a value of 0.0. The *Visible System* SDVF is provided in Figure 11.

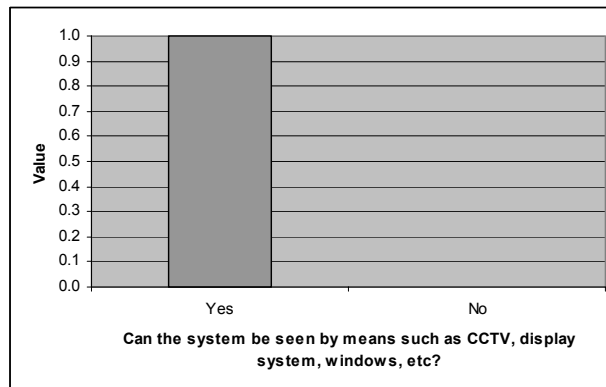

Figure 11: Visible System SDVF

3.2.3.2 Distance SDVF

It is preferred to have a system that will not require the passengers to move their bags at all after checking them in at the airline ticket counter. A system that requires passengers to move their bags 100 feet or more receives a value of 0.0. The *Distance SDVF* in Figure 12 gives a value of 1.0 for a system that does not require passengers to move their bags after tagging at the check out counter. A distance between 0 and 100 feet linearly decreases in value.

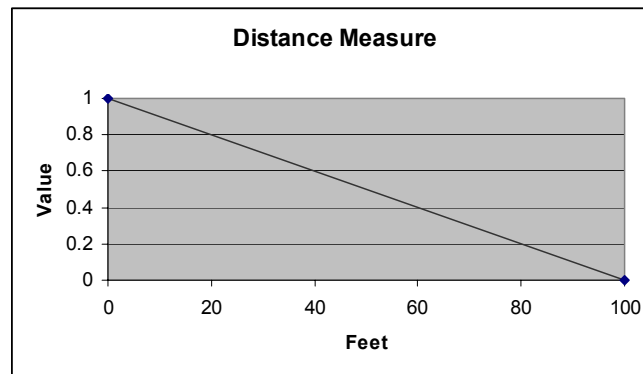

Figure 12: Distance SDVF

3.2.3.3 Number of Times SDVF

The *Number of Times SDVF* is used to assign a value based on how many different locations the passengers have to take their bags after tagging until they turn over the custody of the bags to the screeners or airlines. Having to move bags a number of different times between security stations is considered an inconvenience as was the distance required to move the bags. Not handling the bags at all after tagging receives a value of 1.0. Handling them once receives a value of 0.5 and handling them more than once receives a value of 0.0. The *Number of Times SDVF* is provided in Figure 13.

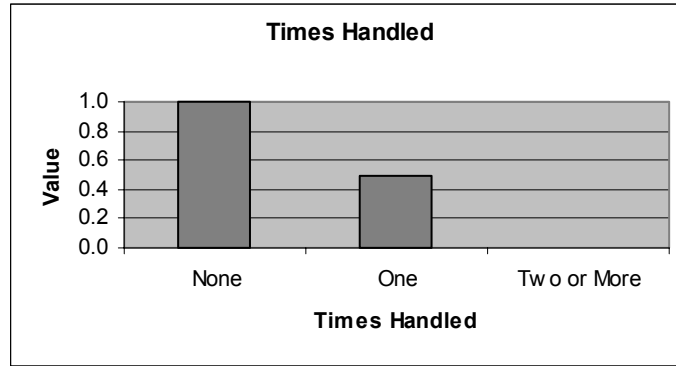

Figure 13: Times Handled SDVF

3.2.3.4 Minutes in Line SDVF

The *Minutes in Line* SDVF is used to determine a value for the time passengers wait while their bags are being screened before leaving them in the custody of the screeners. While the group felt passengers do understand and appreciate the need for security, their patience is not unlimited. Not waiting with the bags at all is the most preferred and receives a value of 1.0. For each minute the passenger waits the value decreases linearly up to 15 minutes or more when the value is 0.0.

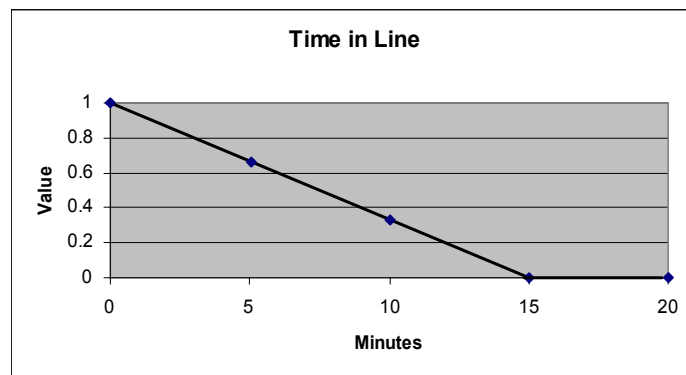

Figure 14: Time in Line SDVF

3.2.4 Efficient Branch

The group desires a system with minimal impact to their staff while accommodating for the various peak passenger flows. It is important that the checked baggage system does not have bottlenecks or delays to the bag processing. Floor space is

a limited resource that has become even more limited since the implementation of the temporary checked baggage system. The screening machines are large; the machines and queues take up this valuable floor space. In addition to the floor space, the delivery method for the bags is an important issue for the airlines. The airlines value independent make up rooms where the cleared bags are delivered. This allows the airlines to load bags without the need to sort through bags traveling with other airlines. Figure 15 illustrates the sub-objectives that comprise the Efficient branch of the checked baggage system hierarchy.

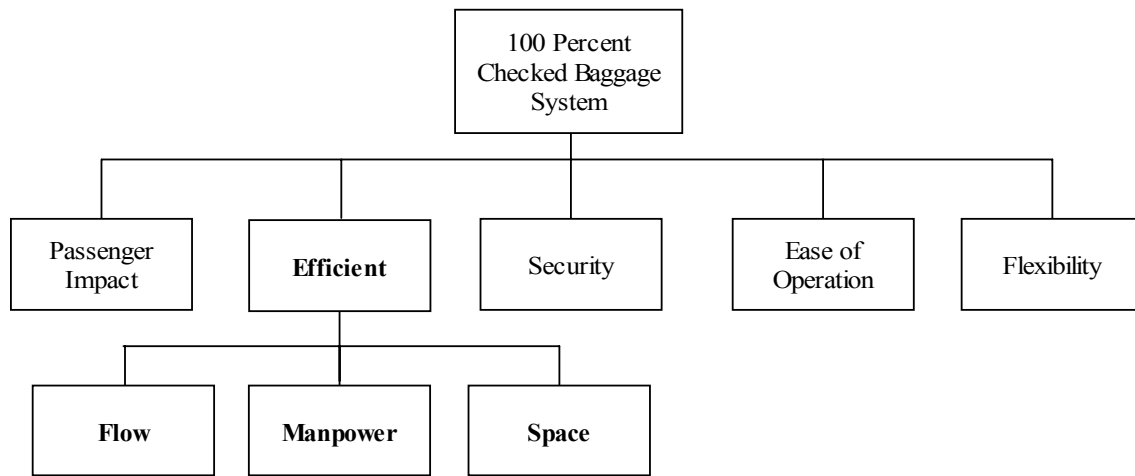

Figure 15: Efficient Branch

The definitions of the sub-objectives within this branch are provided in Table 4.

Table 4: Efficient Sub-objective Definitions

Efficient	Productive baggage system with minimal wasted baggage flow, manpower, and space.
Flow	Throughput of the baggage with emphasis to avoid congestion, bottlenecks, and interruption
Manpower	Personnel fluctuations necessary to accommodate the varying passenger load
Space	Floor space of the airport required for the system

There are four measures used for the Efficient branch tier sub-objectives. These measures are shown in Figure 16.

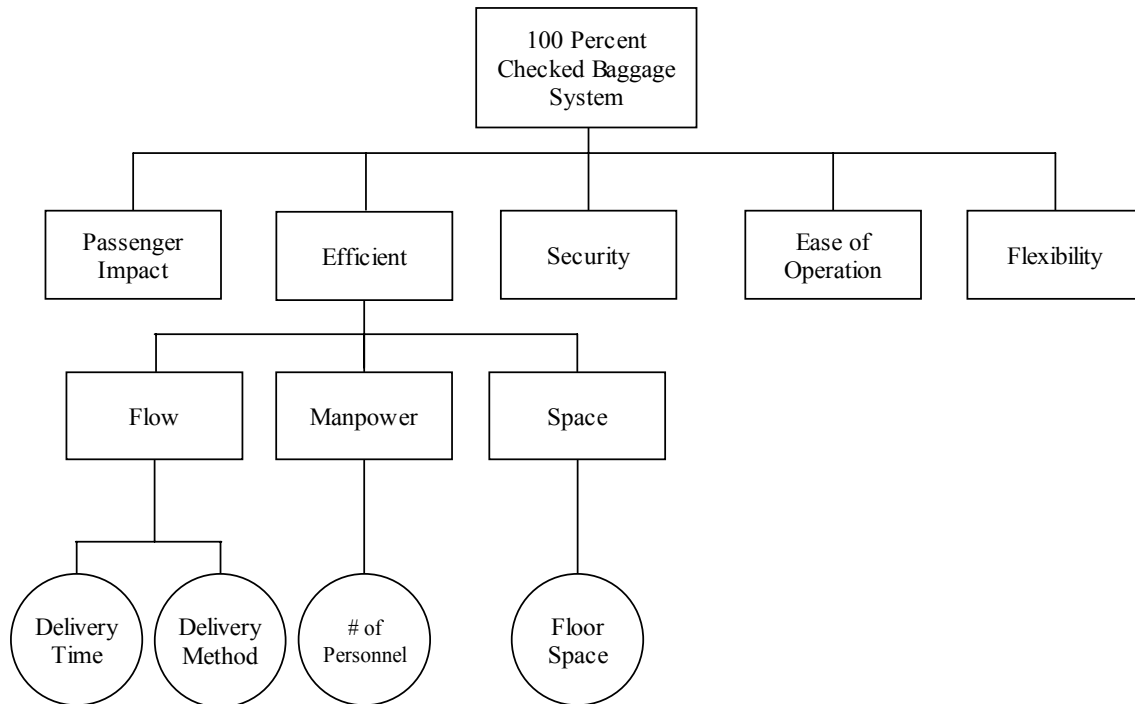

Figure 16: Efficient Branch with Measures

Table 5: Definitions of Efficient Measures

Measure	Definition
Delivery time (minutes)	The time the checked bag takes to get to the make up room once it has been tag at the airline desk and sent to be screened.
Delivery Method	The level of sorting provided to the Airlines when delivered to a Make up room.
Personnel Fluctuation	The change in number of operators required to operate the baggage screening system
Floor Space (Square Feet)	The amount of floor space required from the airport for the operation of the checked baggage system.

3.2.5 Efficient Branch SDVFs

The Efficient branch consists of four measures; Single Dimensional Value Functions were developed for each by the study group. A brief description of each value function is provided separately.

3.2.5.1 Delivery Time SDVF

The *Delivery Time* SDVF is one of the two value functions used for the flow sub-objective. A system that can process bags from the point of being tagged to their arrival at the make up room in seven minutes or less receives a value of 1.0. A system that processes bags in 15 minutes or more receives a value of 0.0. The value for the time in between decreases linearly. Fast delivery times are necessary to ensure enough time to load bags without adversely affecting airlines departure times. This relationship is illustrated in the *Delivery Time* SDVF in Figure 17. (It should be noted that the maximum time will be airport dependent. Fifteen minutes was the desired maximum time for Dayton International Airport.)

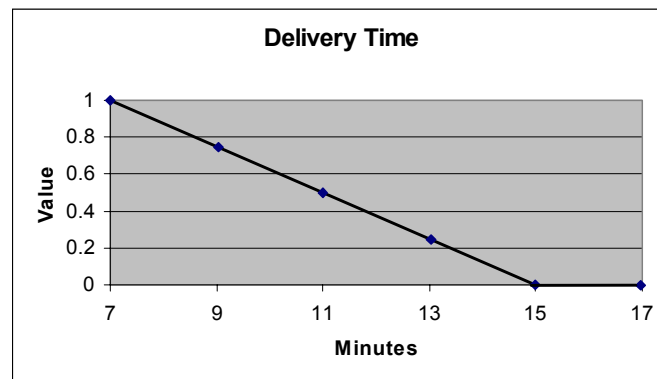

Figure 17: Delivery Time SDVF

3.2.5.2 Delivery Method SDVF

The *Delivery Method* SDVF assigns a value based on how a system delivers bags to the airline make up rooms. The most preferred method is for the system to deliver bags to individual airline make up rooms. This method receives a value of 1.0. The least preferred method is for the system to deliver bags to a common make up room for multiple airlines that requires airline baggage handlers to sort bags. That method receives a value of 0.0. The second most preferred method is for the system to deliver bags to a common make up room but which sorts the bags according to airline. This method receives a value of 0.8. This function is illustrated in Figure 18.

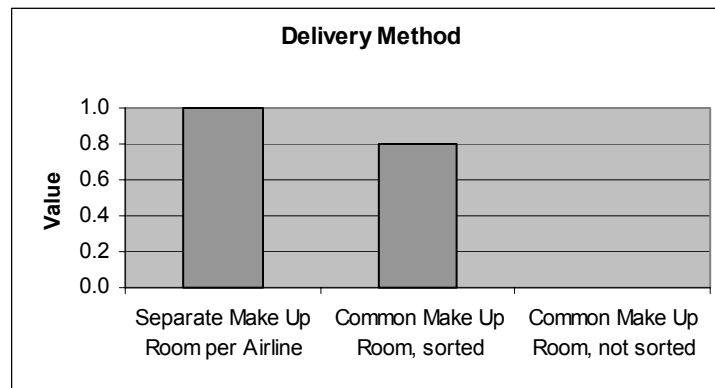

Figure 18: Delivery Method SDVF

3.2.5.3 Fluctuation of Personnel SDVF

The *Fluctuation of Personnel* SDVF captures a value based on the amount of personnel changes necessary to accommodate varying passenger loads. A system that requires a constant number of Personnel is the most preferred and receives a value of 1.0. A system that requires minor fluctuations in personnel levels is the second most preferred, receiving a value of 0.8. Minor fluctuations are variations of ten percent or less. A system that requires major fluctuation in personnel is the least preferred and

receives a value of 0.0. Major fluctuations are personnel variations of more than 10 percent. This relationship is illustrated in Figure 19.

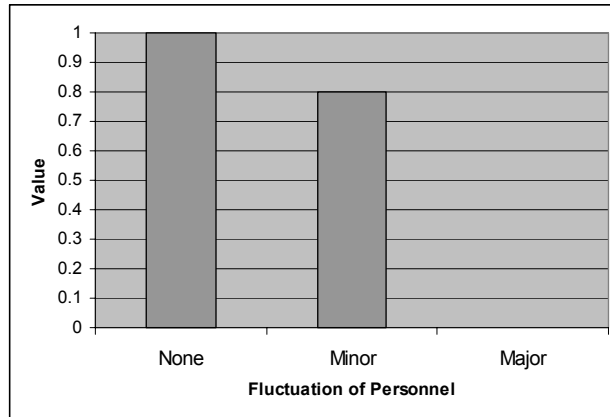

Figure 19: Fluctuation of Personnel SDVF

3.2.5.4 Floor Space SDVF

The *Floor Space* SDVF provides a value based on the amount of terminal floor space required to support the system. It is most preferred to have a system that requires no terminal floor space, such a system would receive a value of 1.0. The second most preferred system would take up no more floor space than currently available to conduct baggage screening in the lobby area without changing the existing floor layout. That system would receive a value of 0.5. The least preferred system would require more floor space than is currently used and that system would receive a value of 0.0. This relationship is illustrated in Figure 20.

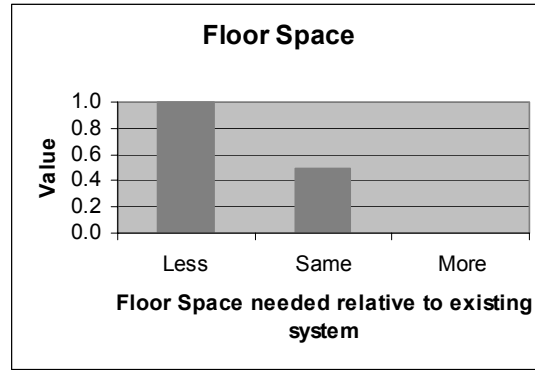

Figure 20: Floor Space SDVF

3.2.6 Security Branch

The vulnerability of the screening system is an important objective since a system that is compromised forces manual bag clearing and thus severely impacts passenger process times. In addition to the vulnerability, the capabilities of the equipment used for the system are important. The capabilities of the equipment must meet minimum standards prior to being certified by the FAA, however. There are different manufacturers of equipment. The study group wants to ensure that the Dayton International Airport uses equipment with the highest level of capabilities. These capabilities include the equipment's performance detecting known explosives, average processing times, and maintenance performance based on fielded explosive systems in operation. The Security sub-objectives as defined by the study group are illustrated in Figure 21.

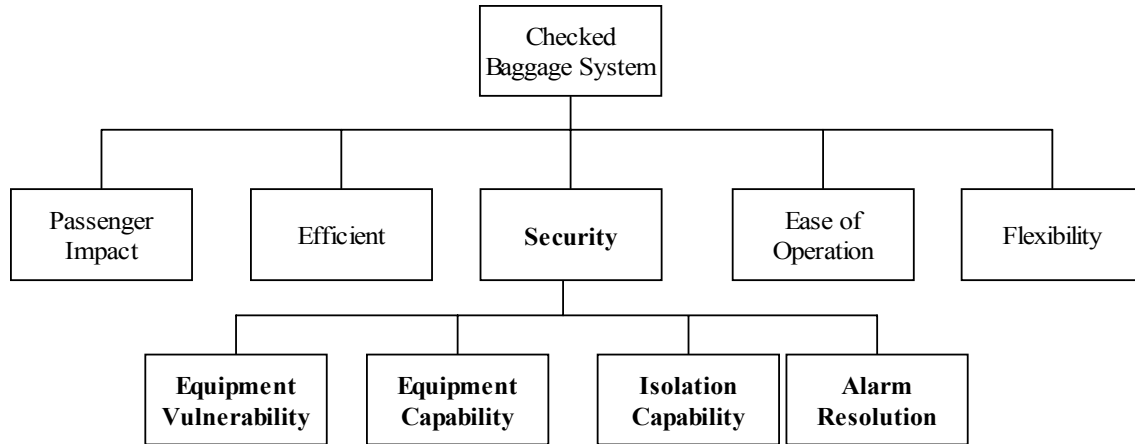

Figure 21: Security Branch

The sub-objectives for the Security branch were defined based on the study group's interpretation of what is important with respect to Security. These definitions are given in Table 6.

Table 6: Security Sub-objective Definitions

Security	Measures to prevent harm to passengers, personnel, and resources supporting the checked baggage system
Equipment Vulnerability	The accessibility of the system to those who intend harm.
Equipment Capability	The ability of the screening system to detect explosives, speed of processing bags, and reliability that the system will be available.
Isolation Capability	The ability of the checked baggage system to separate a bag from the baggage flow so as not to impede bag processing.
Alarm Resolution	Ability of the EDS machines integrated into the checked baggage system to assist operators in determining whether alerts of threat by screening machines are an actual or false threat.

There are five lowest tier objectives for the Security branch. The Security branch of the value hierarchy, with measures, is provided in Figure 22.

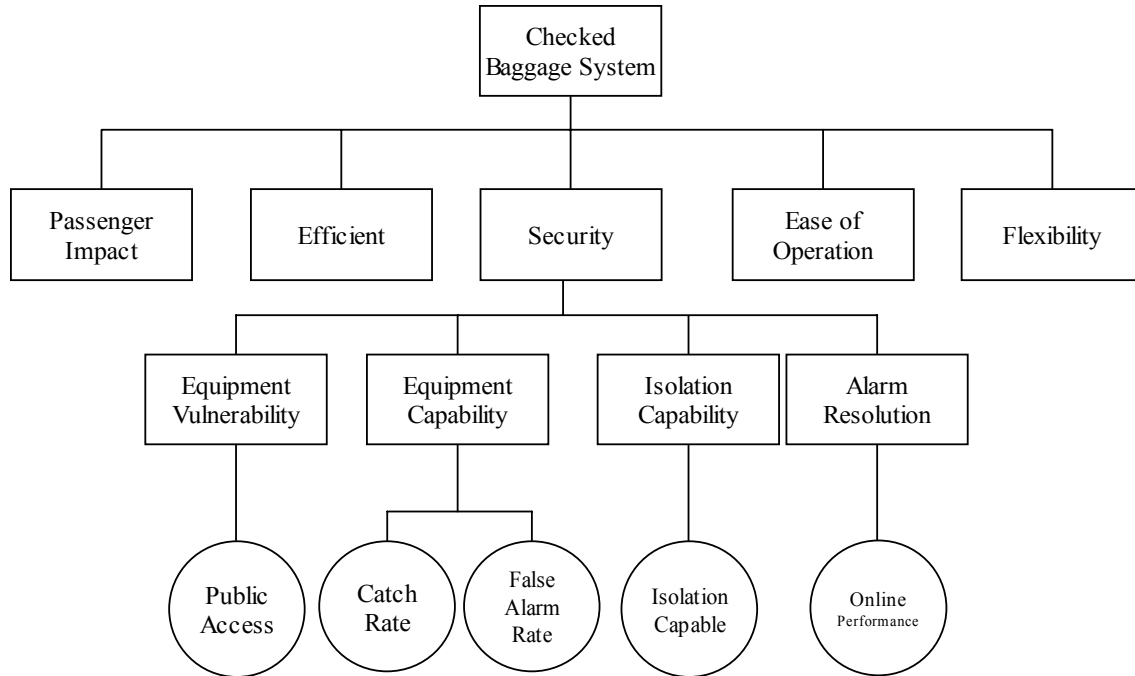

Figure 22: Security Branch with Measures

The definitions of the measures for each of the Security Branch sub-objectives are provided in Table 7.

Table 7: Definitions of Security Measures

Measure	Definition
Public Access	Can the passengers access the system without the need for identification?
Catch Rate	Percentage of known threats identified correctly
False Alarm Rate	The percentage of non threats incorrectly identified as threats
Isolation Capable	Is the system capable of sending a bag identified with a possible explosive to an area that will not impede processing of other bags?
Online Performance	How many alarms can be resolved by the checked baggage system without the need to manual clear the bags?

3.2.7 Security Branch SDVFs

There are five Single Dimensional Value Functions that were developed for the security branch.

3.2.7.1 Public Access SDVF

After discussing the issue, the group concluded that it is preferable that the system not be accessible by the public. Specifically a system inside of the Security Identification Display Area (SIDA) is the most preferred. The SIDA is an area of the airport that requires cleared airport personnel and is therefore not accessible to the public. By securing the baggage screening equipment in the SIDA, the machines are protected from unauthorized tampering and the public has less exposure to unscreened bags. A system that is not accessible to the public receives a value of 1.0. A system that is accessible to the public receives a value of 0.0. The *Public Access* SDVF is provided in Figure 23.

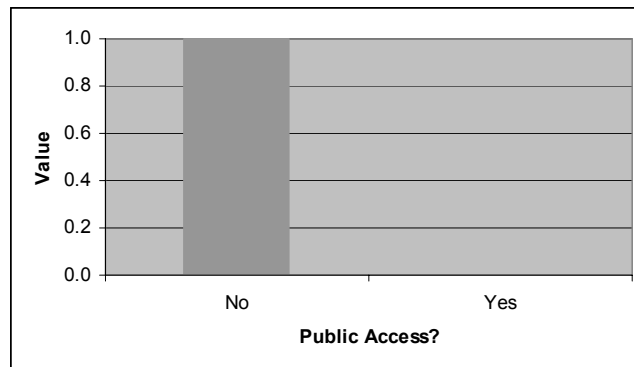

Figure 23: Public Access SDVF

3.2.7.2 Catch Rate SDVF

The *Catch Rate* SDVF converts a high score for a system that maximizes the percentage of known threats that are identified correctly. Operational data could be gathered for this measure based on how different explosive detection equipment performs from Red Team inspections. Red Team inspections are periodic inspections performed by the government to evaluate the effectiveness of the screening machines and operators at detecting bags with actual threats. By collecting this data, a proxy is developed for the machine catch rate. If the data were to show different types of equipment had differing average catch rates in various operational settings, the data may help identify potential improvements. The minimal acceptable catch rate is prescribed by TSA. Any catch rate higher than the required minimum would gain value on this exponential SDVF.

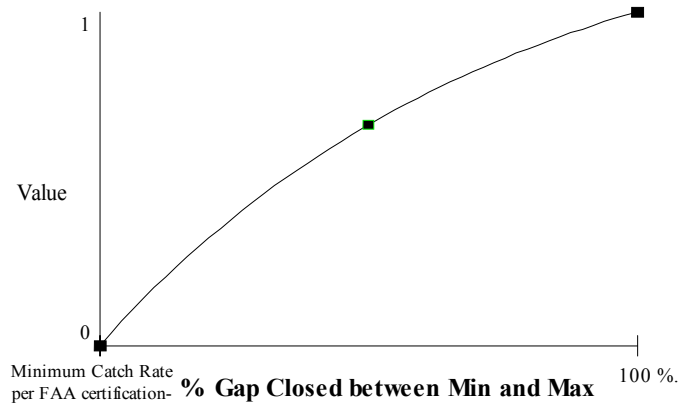

Figure 24: Catch Rate SDVF

Table 8: Data for Catch Rate SDVF

Percent of the Gap between Minimum Catch Rate (Certified by FAA) and 100 Percent	Value
0	0.00
50	0.66
100	1.00

3.2.7.3 False Alarm Rate SDVF

The *False Alarm Rate* SDVF uses the percentage of items incorrectly identified as threats to define a value for equipment capability. A false alarm rate of 0 has a value of 1.0. As the percentage of false alarms approaches 100 percent the value decreases exponentially as illustrated in Figure 25. As with the Catch Rate SDVF, operational data should be used for this measure if made available by the government.

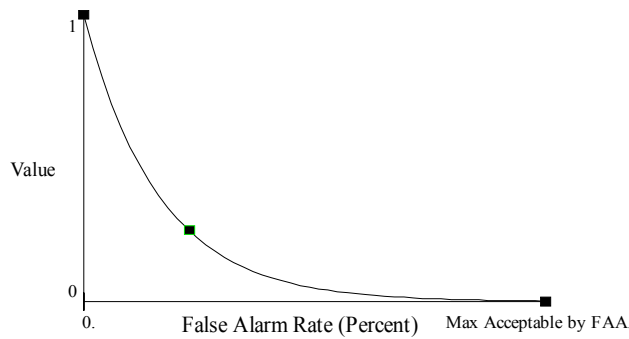

Figure 25: False Alarm Rate SDVF

Table 9: Data for False Alarm Rate SDVF

False Alarm (Percent)	Value
0	1.00
25	0.25
100	0.00

3.2.7.4 Isolation Capable SDVF

It is preferred for a baggage screening system to be capable of isolating bags that are identified as a threat. This isolation capability allows the bag to received additional screening while allowing other bags to continue in the system without being hindered. A system that is capable of isolating bags receives a value of 1.0 and a system that does not have isolation capability receives a value of 0.0. The *Isolation Capable* SDVF is provided in Figure 26.

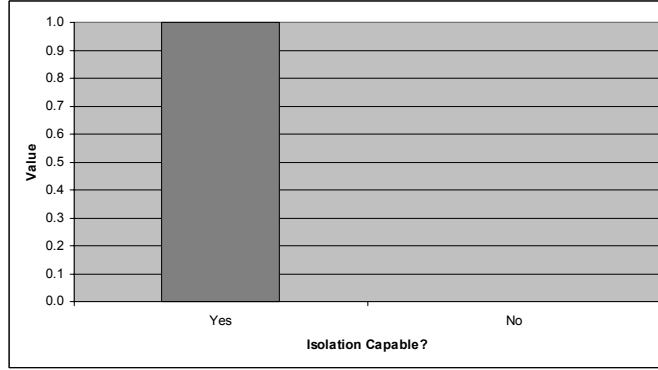

Figure 26: Isolation Capable SDVF

3.2.7.5 Online Performance SDVF

The *Online Performance* SDVF uses the percent of alarms that can be resolved within the screening machines to define a value for alarm resolution. The higher the percentage of alarms handled within the machines without requiring hand searches the better. The *Online Performance* SDVF is provided in Figure 27 and the data points used to generate this Figure is provided in Table 10.

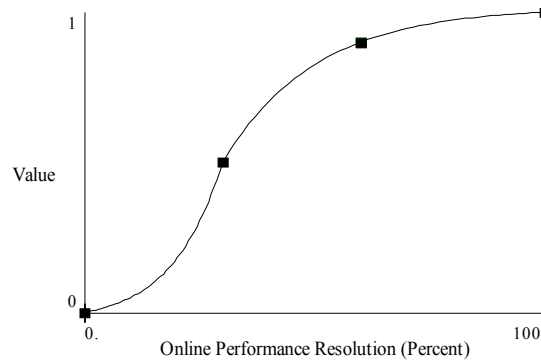

Figure 27: Online Performances SDVF

Table 10: Data Points for Online Performance SDVF

% of Alarms Resolved within EDS	Value
0	0.0
15	0.10
30	0.50
60	0.90
100	1.00

3.2.8 Ease of Operation Branch

The Ease of Operation objective is the fourth fundamental objective in the hierarchy. There are four lowest tier objectives for the Ease of Operation branch. The Ease of Operation branch is provided in Figure 28.

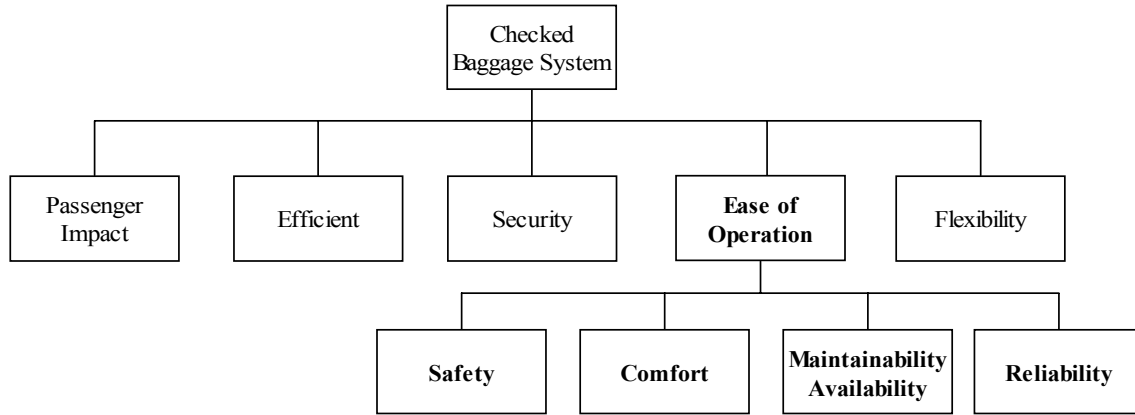

Figure 28: Ease of Operation Branch

The definitions for each of these sub-objectives as defined by the study team are provided in Table 8.

Table 11: Ease of Operation Sub-objective Definitions

Ease of Operation	The safety and comfort for the operators of the baggage screening system along with the maintainability, availability, and reliability.
Safety	Application of engineering and management principles, criteria, and techniques to avoid harm to operators of the system.
Comfort	Condition or feeling of pleasurable ease, well-being, and contentment.
Maintainability / Availability	The probability that a failed system will be repaired
Reliability	The probability that the system will perform as required when operated within its operational limits

Four measures were developed to correspond to the lowest tier sub-objectives for the Ease of Operation branch. This branch, with measures, is provided in Figure 29.

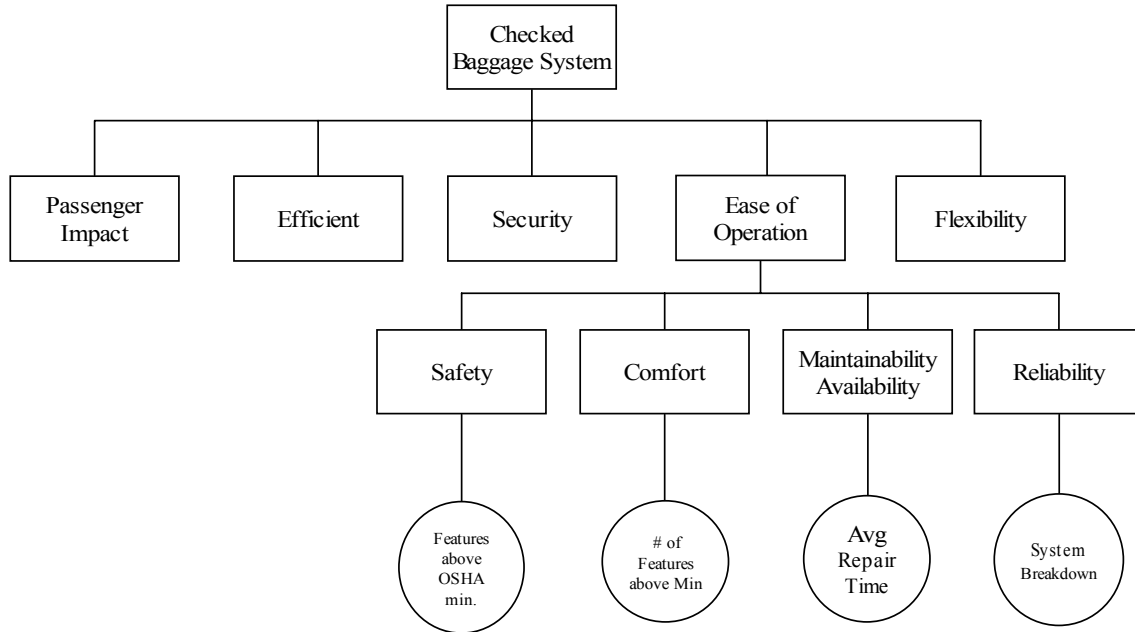

Figure 29: Ease of Operation Branch with Measures

The definitions of these measures defined by the study group are provided in Table 12.

Table 12: Definitions of Ease of Operation Measures

Measure	Definition
# Features above Minimum Required, Safety	Occupational Safety and Health Administration (OSHA) minimum safety features
# Features above Minimum Required, Comfort	Additional features included to system such as cushioned chairs, fans, etc.
Average Repair Time	The time in hours that repairs on the system take
Number of Breakdowns	The number of breakdown in addition to the normally scheduled maintenance downtime

3.2.9 Ease of Operation SDVFs

The Ease of Operation Branch consists of four measures; Single Dimensional Value Functions for the each by the study group. A brief description of each value function is provided separately.

3.2.9.1 Number of Safety Features SDVF

It is desirable to have a checked baggage system with safety features over and above the required features. The TSA and OSHA stipulate required safety features. These required features would serve as the minimum. While clearly valued, these items would receive a score of zero on the measure as it captures additional features. Such features can take any form. For example this could include items such as conveyor shut down switches that isolate portions of the baggage systems while allowing other parts of the conveyor to continue operating. This SDVF is categorical, scoring value for each item above the required minimum features. The increase SDVF is in Figure 30

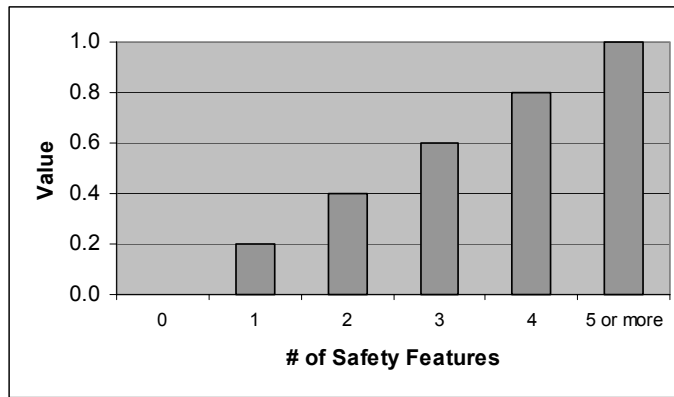

Figure 30: Number of Safety Features SDVF

3.2.9.2 Number of Comfort Features SDVF

It is desirable to have a checked baggage system with comfort features over and above the minimum. The required comfort features stipulated by TSA would serve as the minimum. While clearly valued, these items would receive a score of zero on this measure items as it captures additional features. Such features can take any form. For example this could include items such as screening system monitors with reduced glare to reduce eye strain and will lead to more attentive operators. This SDVF is categorical,

scoring value for each item above the required minimum features. The increase SDVF is in Figure 31

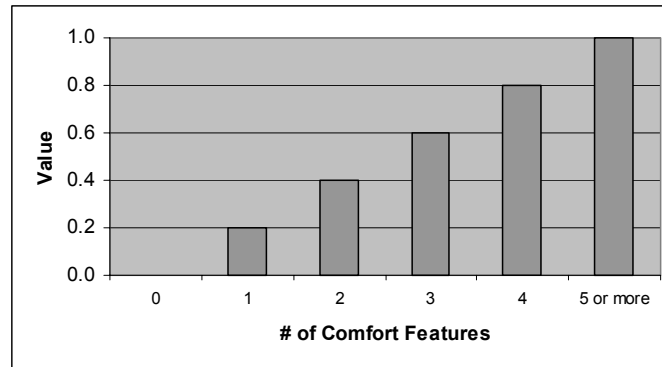

Figure 31: Number of Comfort Features SDVF

3.2.9.3 Time to Repair SDVF

The study group believes it is desirable to have a system with the minimum average repair time. In the case of unscheduled maintenance problems it is important to get the system back up in less than 1 hour in order to minimize the disruption to the passenger and bag flow. A repair that takes more than 24 hours is considered unacceptable and would receive a value of 0.0. This SDVF is categorical. The most preferred repair time of 1 hour or less receives a value of 1.0 and as the repair takes longer the value decreases incrementally. The Time to Repair SDVF is in Figure 32.

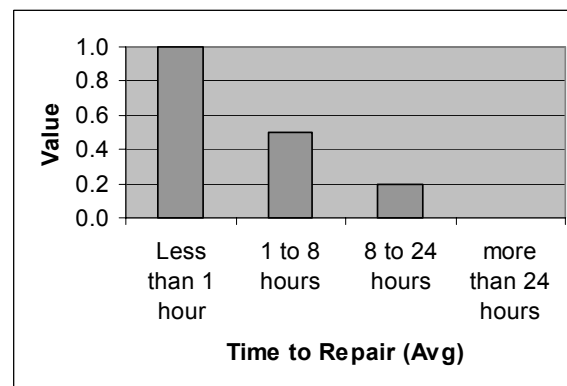

Figure 32: Time to Repair SDVF

3.2.9.4 Number of Breakdowns SDVF

The Number of Breakdowns SDVF provides a value for the Reliability sub-objective. Based on the average number of system breakdowns that occur within a maintenance cycle a value is assigned. The maintenance cycle is defined as 30 days. A system that averages no breakdowns within the maintenance cycle receives a value of 1.0. As the average number of breakdowns increases the value given for the SDVF decreases. A system with 3 or more breakdowns on average per month is considered unacceptable and receives a value of 0.0. This SDVF is provided in Figure 33.

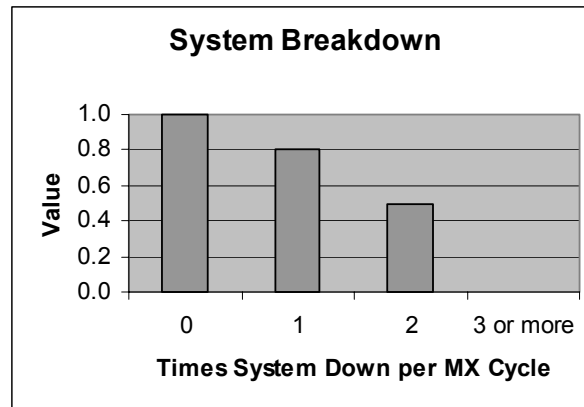

Figure 33: Number of Breakdowns SDVF

3.2.10 Flexibility Branch

The Flexibility objective is the fifth first tier sub-objective. The Flexibility Branch consists of three sub-objectives. The Flexibility Branch is expanded in Figure 34.

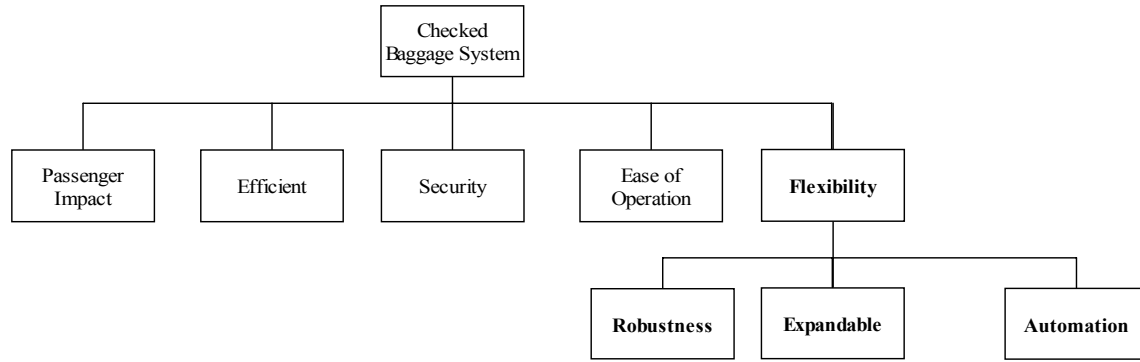

Figure 34: Flexibility Branch

The definitions described by the study group for these Flexibility sub-objectives are provided in Table 10.

Table 13: Flexibility Objective Definitions

Flexibility	The capability of adapting to new, different, or changing requirements
Robustness	Holds up well under exceptional conditions
Expandable	Capable of increasing the size of scope of the system in the future
Automation	Operation or control of a process performed by equipment rather than manually

There are six lowest tier objectives for the Flexibility branch. This branch, with measures is provided in Figure 35.

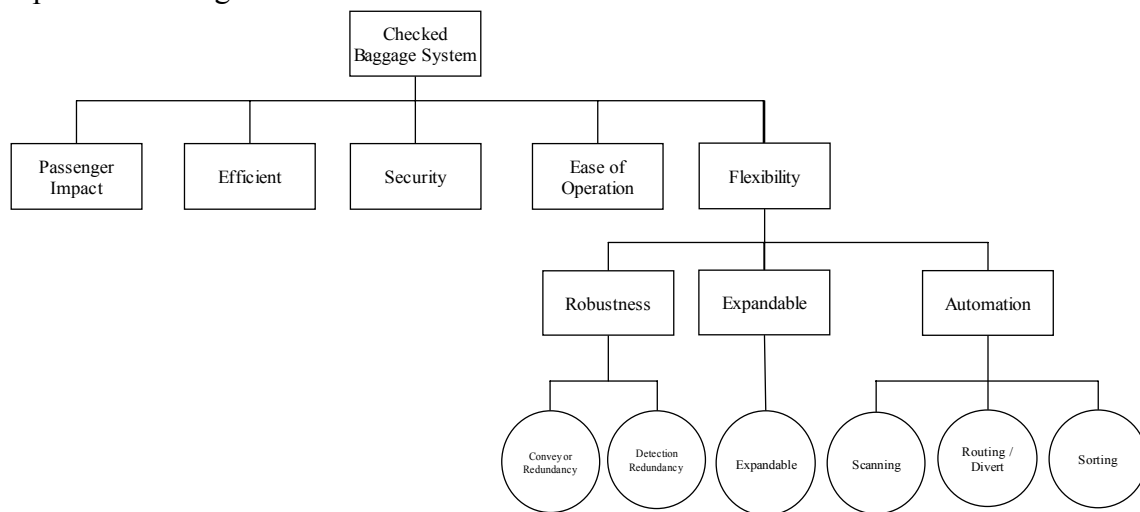

Figure 35: Flexibility Branch With Measures

The definitions developed for the Flexibility sub-objective measures are provided in Table 11.

Table 14: Flexibility Measure Definitions

Measure	Definition
Conveyor Redundancies	How many back up measures are available on the conveyor system in case of a conveyor breakdown?
Detection Redundancies	How many back up detection systems are available to screen bags identified as threats?
Expandable	Can the system be expanded to take a larger passenger load?
Scanning	Is the system capable of tracking bags with identification such as bar code?
Routing / Divert	Is the system capable of routing and diverting bags automatically?
Sort to Airline Make Up	How does the system sort the passenger bags to make up Areas?

3.2.11.1 Conveyor Redundancy SDVF

The Conveyor Redundancy SDVF is one of two value function for the Robustness sub-objective. It is desirable for the checked baggage system to have redundant ability. The conveyor system may have to be shut down to perform maintenance or clear jammed bags. It is preferred to have a system that is capable of moving bags on alternate conveyor routes to avoid bag process delays or the requirement for the manual transfer of bags. The most preferred realistic number of redundant conveyor system is 3 or more for the Dayton International Airport. The least preferred option is for the checked baggage system to have no redundant conveyor systems. This SDVF is provided in Figure 36

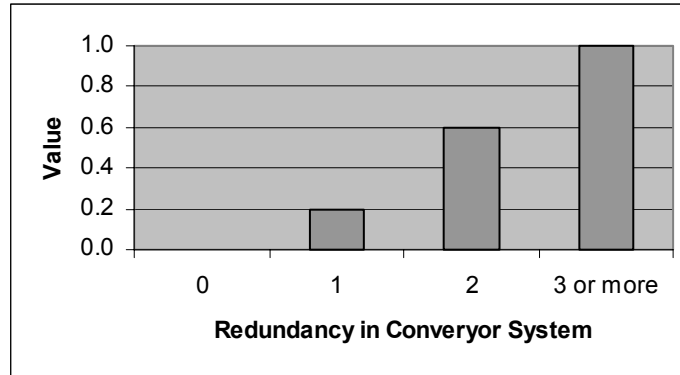

Figure 36: Conveyor Redundancy SDVF

3.2.11.2 Detection Redundancy SDVF

It is desirable to have a checked baggage systems that has multiple automated layers of detection abilities. The Detection Redundancy SDVF is the second value function used for the Robustness sub-objective. It is used to assign a value based on the number of redundant detection capabilities built into the system. A system that has 3 or more redundant detection features receives a value of 1.0.

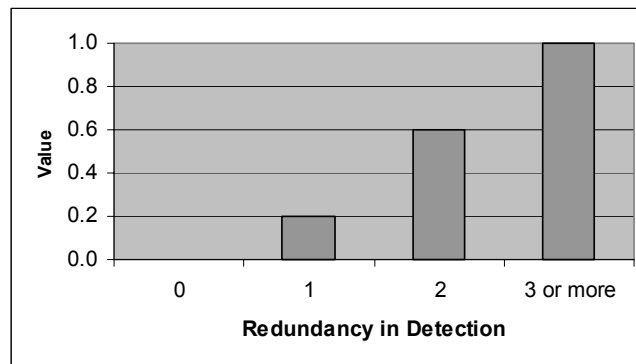

Figure 37: Detection Redundancy SDVF

3.2.11.3 Expandable SDVF

It is most preferred to have a checked baggage system that can be expanded to take on a larger passenger load accommodating any expansion in passenger loads and air carriers. The Expandable SDVF assigns a value of 1.0 for a system that is able to

accommodate additional airlines should the airport expand the number of airlines. This value function is provided in Figure 38.

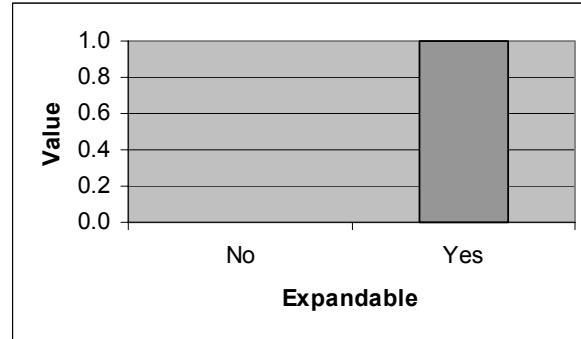

Figure 38: Expandable SDVF

This next group of measures captures the value of various automated effects. The highest value would be gained by an automated process for all three of these factors. However, the separate measures capture the ability to add certain of these automated functions separately from the others.

3.2.11.4 Tracking SDVF

It is preferred to have a checked baggage system that is capable of tracking bags in the screening process and can tell where a checked bag is located. The Tracking SDVF assigns a value of 1.0 for a system that automatically tracks checked bags and assigns a value of 0.0 for a system that is not capable of tracking automatically. This SDVF is provided in Figure 39.

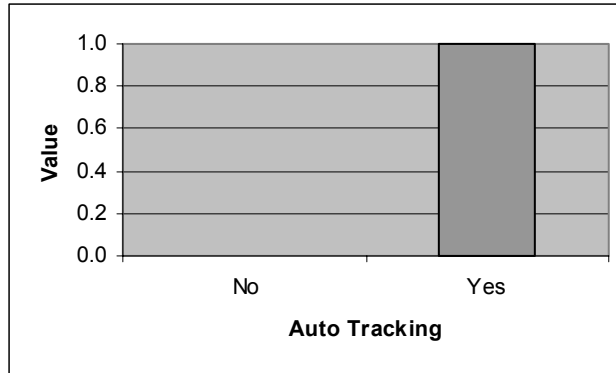

Figure 39: Tracking SDVF

3.2.11.5 Routing / Divert SDVF

The study group prefers a checked baggage system is capable of automatically routing and diverting bags. Such automated handling reduces personnel needs and, when properly implemented, provides better service than manual handling.

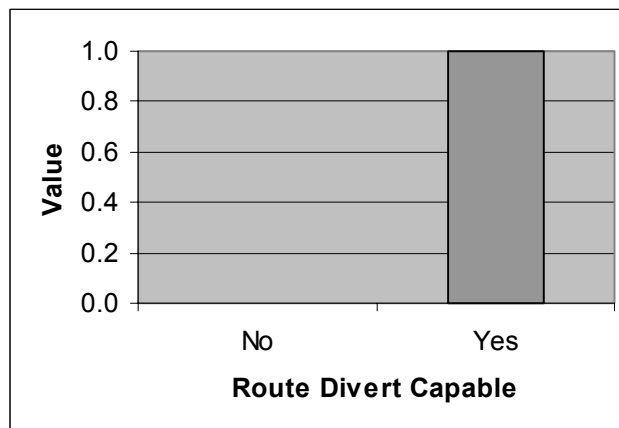

Figure 40: Routing Divert SDVF

3.2.11.6 Sorting SDVF

The Sorting SDVF is the third value function for the Automation sub-objective. It used to assign a value of 1.0 for a system that is capable of automatically sorting bags to airline make up rooms.

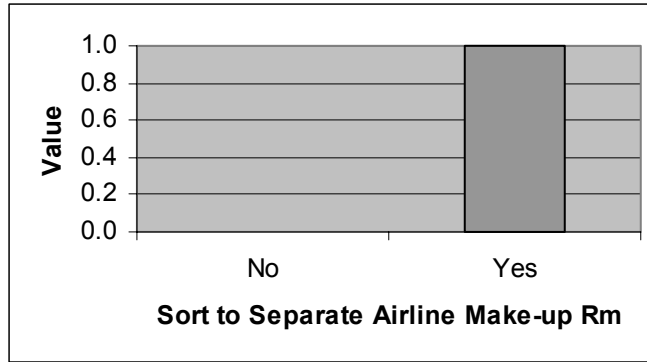

Figure 41: Sorting SDVF

The Checked Baggage System Hierarchy includes 23 measures used to assess how well potential 100 percent checked baggage system alternatives provide what was deemed important by the study group. Several of these measures will require data that was not available to the study group at the time. However these were deemed important enough to be included.

3.3.1 Decompose Cost

The study group identified three areas of concern for cost. These areas were identified during the affinity diagram process used to define the objectives for the checked baggage system hierarchy. The cost areas were developed into three sub-objectives. The first is the cost associated with the Personnel required to operate the system. The second sub-objective is the cost associated with the type of construction required to support the checked baggage system. The third is the cost from acquisitions to support the checked baggage system such as a conveyor system used to move and transfer bags through screening machines. The definitions for these sub-objectives are provided in Table 15.

Table 15: Cost Objective Definitions

Cost	Expenditure of time, money, and resources to
People	The personnel necessary to operate the system
Infrastructure	The level of construction necessary to install the system.
Acquisition	The purchases made for a system which includes conveyor systems, display monitors.

The cost hierarchy with measures is provided in Figure 42.

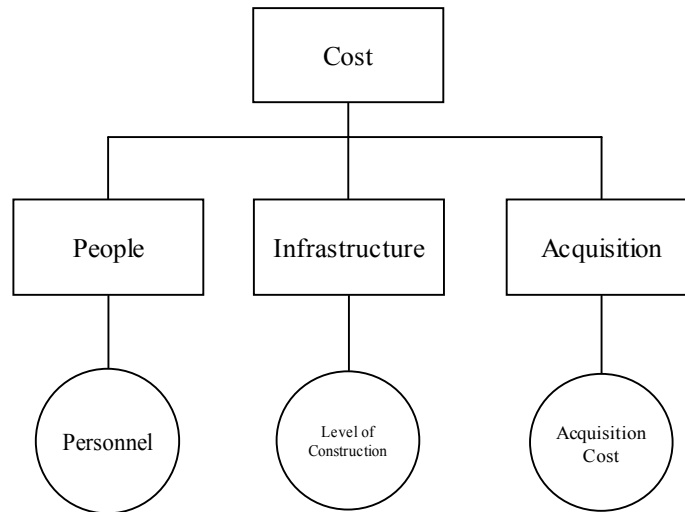

Figure 42: Cost Hierarchy with Measures

The definitions of these measures as defined by the study group are listed in Table 16.

Table 16: Cost Objective Definitions

Measure	Definition
# of People	The number of operators required to run and maintain the system.
Level of Work	Type of construction required to support the new system.
Cost of System	The net present value of the system over its anticipated lifecycle.

3.3.2.1 Personnel SDVF

The Personnel SDVF uses the number of operators required for the system per shift to define a value for personnel. The most preferred number of operators is 3 which

receives a value of 1.0. The least preferred is 10 or more operators which receives a value of 0. The value decreases linearly as the number of operators increases from 3 to 10.

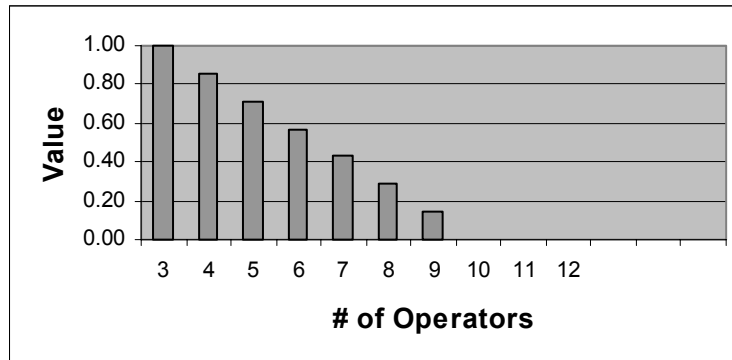

Figure 43: Personnel SDVF

3.3.2.2 Level of Construction SDVF

The Level of Construction SDVF is used to obtain a value for the amount of construction necessary to install the checked baggage screening system. A system that can be installed without construction to the facility is most preferred and receives a value of 1.0. A system that requires minor work includes work such as the movement of non-load bearing walls and renovations within the existing footprint of the facilities receives a value of 0.5. A system that requires major work includes such work as the movement of load bearing walls, reinforcement of floor to increase loading capability, and renovations that expand the existing footprint of the facilities receives a value of 0.0.

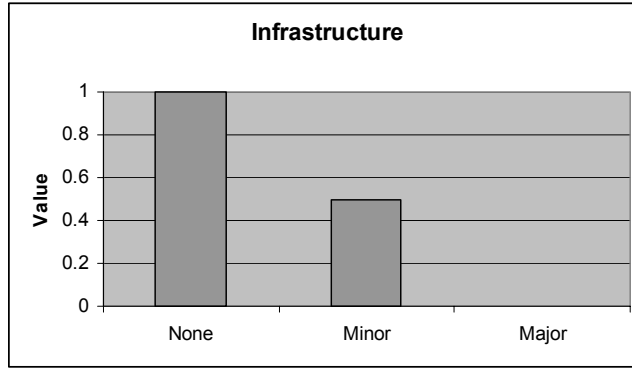

Figure 44: Level of Infrastructure SDVF

3.3.2.3 Acquisition SDVF

The Acquisition SDVF is used to assign a value based on the net present value (NPV) of conveyor systems, facility modifications, and construction to support the system. Note that this cost is exclusive of the cost of the EDS machines. These machines are not currently a cost incurred by the Dayton International Airport. A system that will not incur any cost to the Airport for these items is the most preferred and receives a value of 1.0. A system that requires 1.5 Million dollars (NPV) or more is the least preferred and receives a value of 0.0. As the cost for these items moves from zero dollars to 1.5 Million dollars (NPV) the value decreases linearly. This SDVF is illustrated in Figure 45.

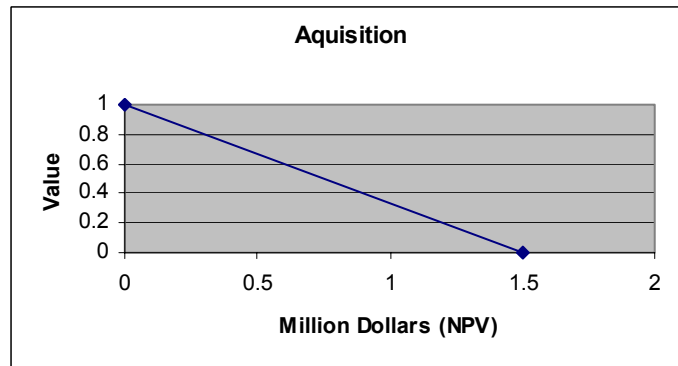

Figure 45: Acquisition SDVF

3.4 Step 5: Weight the Hierarchy

The hierarchies consist of several different objectives which are not of equal importance. It is necessary to weight the hierarchy from the decision maker's perspective. The direct weight method, discussed in Chapter 2, was used to weight the hierarchy. The weighting for the hierarchy was performed by two members of the Director of Aviations staff. Both were members of the study team and were familiar with the hierarchies, measures, and value functions already defined.

3.4.1 Weights for 100 percent checked baggage system

The weights were elicited using the direct weighting method. Weights were assigned locally within each branch of the hierarchy. The 100 percent checked baggage system hierarchy is provided in Figure 46. Starting with the lowest tier of the hierarchy, which are the measures, each measure was weighted based on its relative importance to the other measures used for the same sub-objective. If only one measure was used for a sub-objective it received 100 percent of the weight (100 marbles). If a sub-objective had more than one measure, for example two measures, the decision makers compared the importance one measure in terms of the other. If one measure was determined to be twice as important as the other then the more important measure would receive 66 marbles while the less important measure would receive 33 marbles. Weights were assigned locally beginning with the Passenger Impact Branch moving to the right for the remaining four branches. Weights for the Passenger Impact Branch are provided in Figure 46. After weights were assigned within each Branch the Branches, first tier objectives of the overall hierarchy were given weights using the same 100 marble direct

weight method. The weight assigned to the other four branches of the 100 percent checked baggage hierarchy are provided in Appendix A.

3.4.1 Weight Checked Baggage System Hierarchy Local

There are a total of 23 measures for the Checked Baggage System Hierarchy. These measures, displayed below their corresponding sub-objectives, are used to attain how well an alternative meets the objectives defined in the hierarchy. The decision maker provided weights within each branch. Therefore the weights the decision makers assigned to the measures represent the importance of the measures within each branch of the hierarchy. These weights for the lowest tier of each branch sums to 1.0.

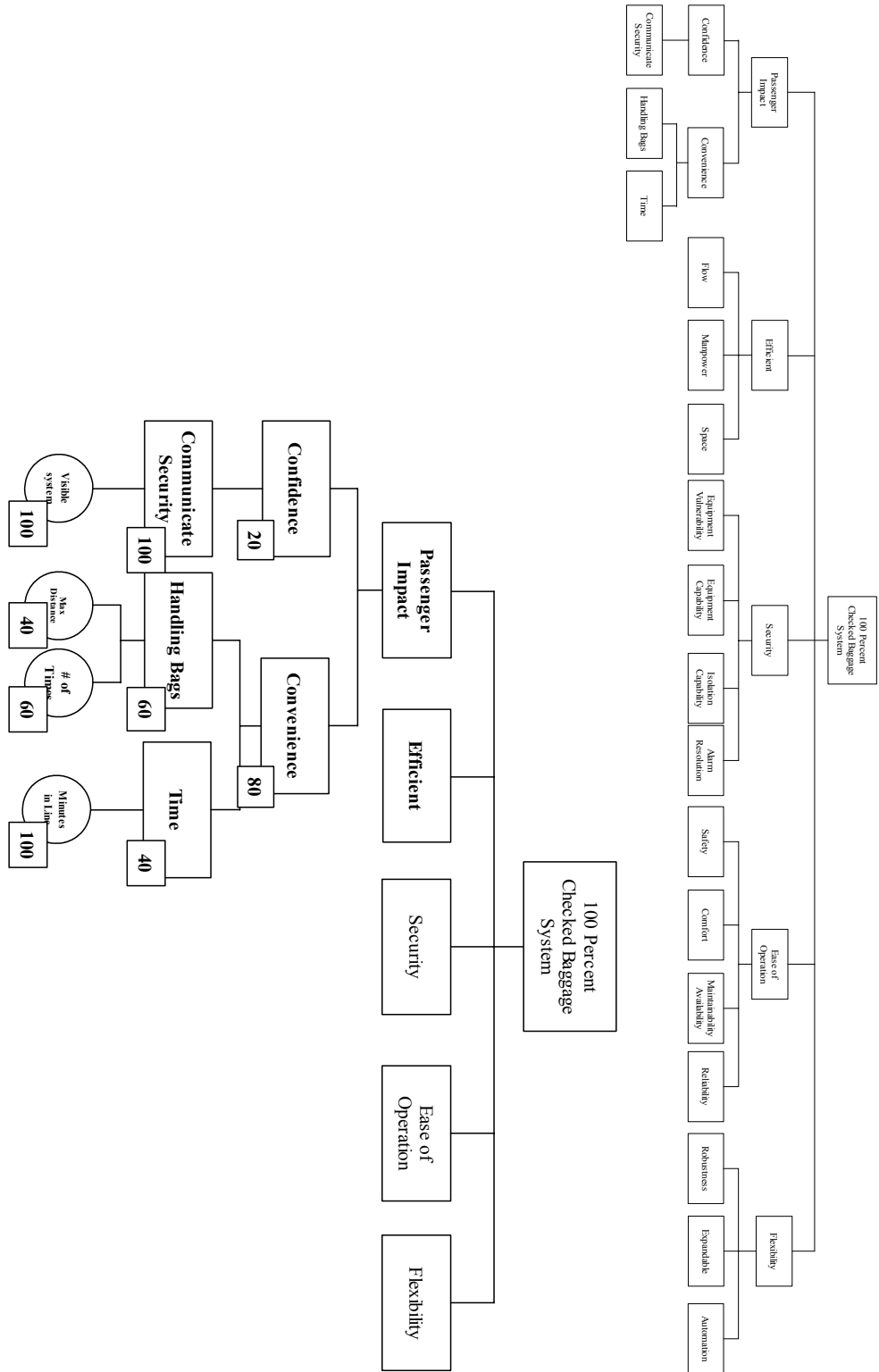

Figure 46: Checked Baggage System Hierarchy and Passenger Impact Branch Local Weights

3.4.2 Weight Checked Baggage System Hierarchy Global

The global weight for each measure is calculated by multiplying the local weight given to the sub-objectives and weight of each objective located above that measure until the fundamental objective is reached. The global weights for the 23 measures in the 100 Percent Checked Baggage System Hierarchy must sum to one. These weights represent the importance that each measure has to the fundamental objective as assigned by the decision maker. The 100 Percent Checked Baggage System Hierarchy global weights are provided in Figure 47.

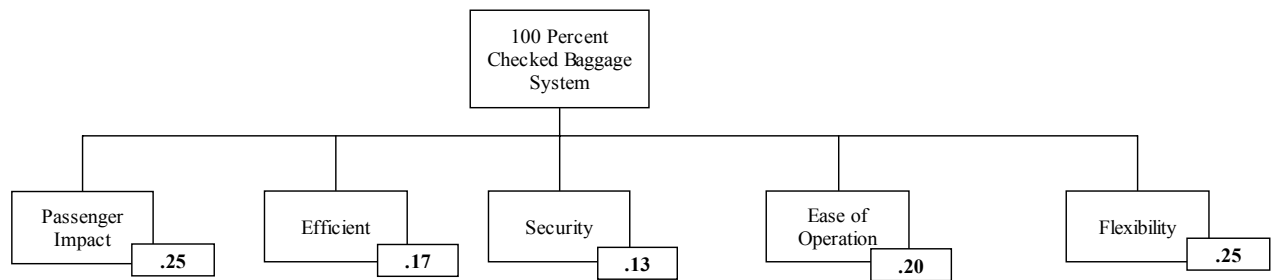

Figure 47: Checked Baggage System Hierarchy First Tier Weights

The Passenger Impact and Flexibility tier objectives received 0.25 of the weight each. They were deemed the most important to the Director of Aviation. The Ease of Operation objective was given a weight of 0.20. The Efficient objective was given a weight of 0.17. The Security objective was given a weight of 0.13. Security was given the least weight but this is not because security is not important. The security objectives provide value to capabilities above and beyond the minimum accepted criteria of the FAA and TSA. These minimum accepted standards are considered stringent. Therefore

the other objectives were given more weight. The Passenger Impact and Flexibility objectives were given the most weight because they were seen as the most important to the passengers and the ability to accommodate various passenger loads. The Ease of Operation objective was given more weight than the Efficient objective because the standards for the workers were deemed as more important than the Efficient objectives.

3.4.3 Weights for Cost

The direct weighting method was also used to weight the cost hierarchy. Since this hierarchy is small in size, (only includes three measures), both the local and global weights are provided in Figure 48.

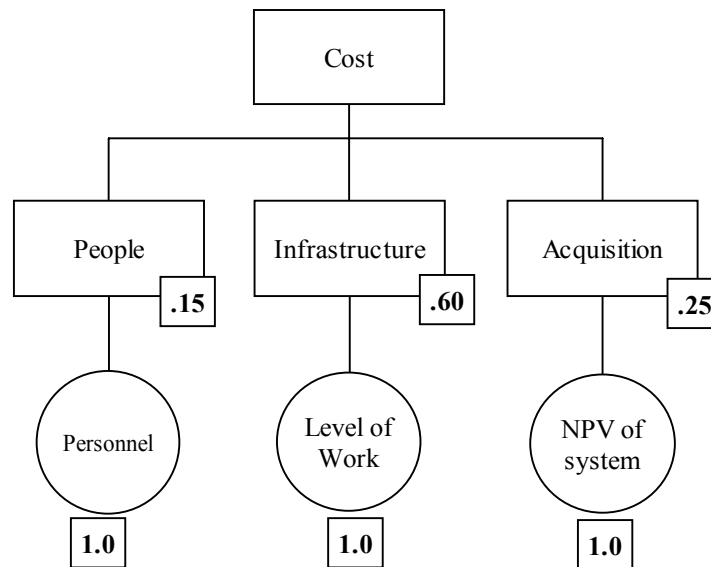

Figure 48: Cost Hierarchy with Weights

3.5 Summary

This chapter covered in detail the creation of a value hierarchy for a 100 percent checked baggage system from the perspective of the Director of Aviation at Dayton International Airport. This is coupled with a “cost hierarchy” which captures the cost of

such a system. The characteristics valued by the stakeholders also provide guidance to system designers. These values clearly delineate design preferences of the stakeholders. The model is now available to the Dayton International Airport, or any other airport that wishes to adopt it. Chapter 4, using a notional example, illustrates how alternatives may be analyzed once they are developed.

Chapter 4. Data Collection & Analysis of Results

The 100 percent checked baggage and cost hierarchies developed during the previous five steps were done so through a series of five group meetings with the integrated study team. The minutes from all group meetings are provided in Appendix B. During a sixth meeting, the Dayton International Airport team members discussed alternatives to use to illustrate the validity of using these hierarchies to evaluate and compare potential checked baggage system hierarchy. Dayton International Airport has an interim system in place that met the requirement for 100 percent screening of checked baggage. The study group is interested in maximizing the value obtained in a checked baggage system. Therefore the group desired to use the current system as one alternative. The group provided several of their desired preferences throughout the model development process. These preferences were used to develop a notional example to provide a comparison.

4.1 Step 6 Alternative Generation

At this point of the VFT process, alternatives are generated with the intent of meeting the objectives defined in the two hierarchies. Several alternatives should be used to provide comparison for how each meets the objectives formed in the hierarchies. For this research two **notional** alternatives were used for illustrative purposes, the current Terminal floor system and a Hypothetical Inline system. The Terminal floor system, along with this notional Inline system, was used to demonstrate the concepts for the baggage system and cost hierarchies. The notional alternative is an inline system which is integrated into a baggage handling conveyor system.

4.1.1 Terminal Floor System – Interim as of 31 December 2002

This interim system consists of the placement of EDS and Explosive Trace Detection machines in the airport lobby directly in front of the airline ticket check in counters. This was used to meet the mandate for 100 percent screening. This system did not require facility modifications or construction.

4.1.2 Hypothetical System, (Inline System)

The Hypothetical System alternative is roughly based on the preferences gathered from the study group meetings. This is an inline system integrated into a baggage handling system. This system allows passengers to leave their checked bags in the custody of the Airlines after check-in. The bags are then transferred through the explosive screening machines and process via a conveyor system directly to the airline make up rooms. Again, it should be noted that this is a hypothetical system, whose scores are notional.

4.2 Step 7 Alternative Scoring

Scoring of the alternatives is typically performed by first gathering data needed for each of the hierarchy measures defined for the lowest tier objectives. This may involve historic data, operational parameters or expert opinion. The single dimensional value functions are then used to obtain a value score of each measure.

4.2.1 Checked Baggage System

The notional data used in this illustration for both the current system and hypothetical system are provided in Table 17.

Table 17: Checked Baggage System Hierarchy Notional Data

Branch	Measure Title	Terminal Floor System	Inline System
Passenger Impact			
	Visible System	Yes	Yes
	Distance	30 ft	0 ft
	# of Times	1	0
	Minutes in Line	7 minutes	0 minutes
Efficient			
	Delivery Time	10	10
	Delivery Method	separate make up room by airline	separate make up room by airline
	Personnel Fluctuation	minor	none
	Floor Space	Same	Less
Security			
	Public Access	Yes	No
	Catch Rate	0	0
	False Alarm Rate	0	0
	Isolation Capable	No	Yes
	Online Performance	0	0
Ease of Operation			
	OSHA Features	1	1
	Comfort Features	1	1
	Average Repair Time	Less than 1 hour	Less than 1 hour
	Number breakdowns	0	0
Flexibility			
	Conveyor Redundancies	0	1
	Detection Redundancies	1	1
	Expandable	Yes	Yes
	Scanning	No	Yes
	Routing	No	Yes
	Sort to Airline	No	Yes

4.2.2 Cost Hierarchy

The notional cost data used for the measures in the cost hierarchy for both the Terminal Floor System and Hypothetical system alternatives are provided in Table 15.

The number of personnel data was provided from the study group based their experience with the current system operation as well as that expected from an inline system that is integrated into an automated baggage handling system. The current system required no work on the airport infrastructure. The hypothetical system would require significant work on the infrastructure due to the fact that there is not enough room behind the airline ticket counter for an inline system. The current system required no acquisition costs. The study group estimated, based on their experience, that the inline system would require approximately \$1.5M in acquisition for a conveyor system. A summary of this notional data is provided in Table 18.

Table 18: Cost Hierarchy Notional Data

Branch	Measure Title	Terminal Floor System	Inline System
Personnel			
	Number of Personnel	8	3
Infrastructure			
	Level of Work	None	Major
Acquisition			
	NPV for System	\$0	\$1.5M

4.3 Step 8 Deterministic Analysis

Deterministic Analysis uses the additive value function to obtain an overall score for each alternative. The global weights assigned by the decision maker for each of the measures are multiplied by the value obtained from the measures' SDVF. These calculations were carried out using the Logical Decisions for Windows Version 5.114 software. The Dayton International Airport model had previously been set-up in the Logical Decisions software as the earlier steps were completed.

4.3.1 Checked Baggage System Hierarchy

The checked baggage system hierarchy included 23 measures. The additive value function obtains an overall score for an alternative by adding the global weight for each measure multiplied by the value obtained by that measures value function. The best possible score for an alternative is 1.0. The scores for each alternative are provided in Figure 49. This figure also provides a visual display for each of the five branches within the hierarchy.

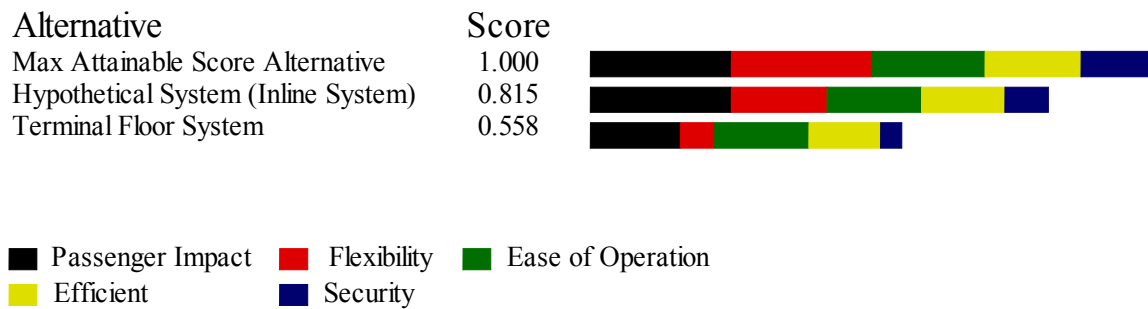

Figure 49: Alternative Rankings for Checked Baggage System Hierarchy

The notional Inline System clearly scored higher than the Terminal Floor System for four of the branches in this example. The two alternatives received the same score for the Ease of Operation branch as both used the same assumptions. With the same illustrative data used; their scores were expected to be the same. The software allows comparison charts such as in Figure 49 to be developed for any tier or branch tier of the hierarchy.

4.3.2 Cost Hierarchy

The cost hierarchy included 3 measures. The notional scores for each alternative for cost are provided in Figure 50. This figure also provides a breakout for each of the three objectives of the hierarchy.

COST

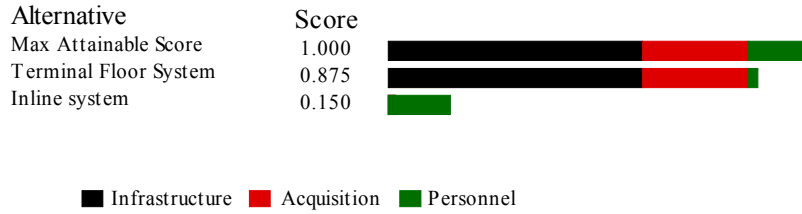

Figure 50: Alternative Rankings for Cost Hierarchy

The Terminal Floor System scored better for both the Infrastructure and Acquisition objectives. The Hypothetical System scored better for the Personnel objective. Overall, the Terminal Floor System is preferred on the cost hierarchy.

4.3.3 Cost / Benefit Comparison

The most preferred checked baggage system would score a 1.0 for both the checked baggage system hierarchy and the cost hierarchy. However, it is unlikely an alternative could capture a maximum score of 1.0 from both hierarchies. A system that scores high for the checked baggage system hierarchy may be more costly, perhaps requiring construction or higher acquisition costs. Figure 51 illustrates the tradeoffs involved between the benefit and cost.

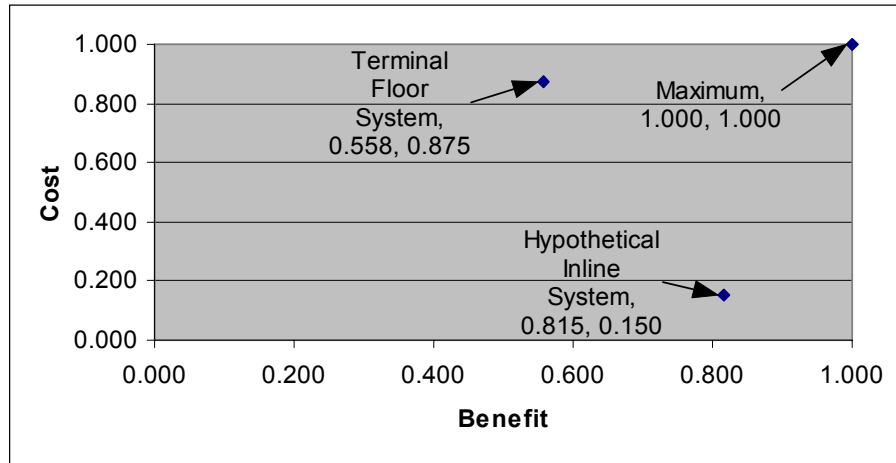

Figure 51: Cost Benefit Plot

The cost and benefit scores for both of the notional alternatives have been plotted in Figure 51. The Inline System scored very low on cost (0.150) while achieving a high benefit score (0.815) (It should be noted that a low cost score is undesirable.). An alternative such as the Inline System achieves a good score for the checked baggage hierarchy because it is automated, manpower efficient, and provides a high level of customer convenience. However it will require acquisition and infrastructure modifications costs which causes it to receive a lower score for cost. The Terminal Floor System receives higher marks in the opposite manner, high score for cost and a low score for benefit. Additionally alternatives could be evaluated in this manner to provide a means of differentiating between systems that score relatively the same for the benefit but receive different cost scores. The ultimate decision makers will need to determine their preferences or trade-off between these costs and benefits.

4.4 Step 9 Sensitivity Analysis

Sensitivity Analysis was performed on each of the first tier objectives to illustrate weight sensitivity. Questions often arise on the weighting. The one way sensitivity

analysis changes the weight of one objective while holding the proportion of the weights among the remaining objectives. If the choice is insensitive to a weight change, discussion of the weight is usually curtailed. If the choice is sensitive to the weights, this suggests careful study of the weight.

4.4.1 Checked Baggage System Hierarchy

Sensitivity analysis determined that in this simple illustrative example, the Hypothetical System was dominant for each objective. An example of sensitivity analysis performed on the Passenger Impact objective illustrates this finding in Figure 52. The decision maker gave Passenger Impact a weight of 0.25. Regardless of the weight assigned to Passenger Impact, the value for the Inline System is the higher of the two alternatives. The same held true for the other measures. Again, such analysis can be carried out at any tier of the hierarchy.

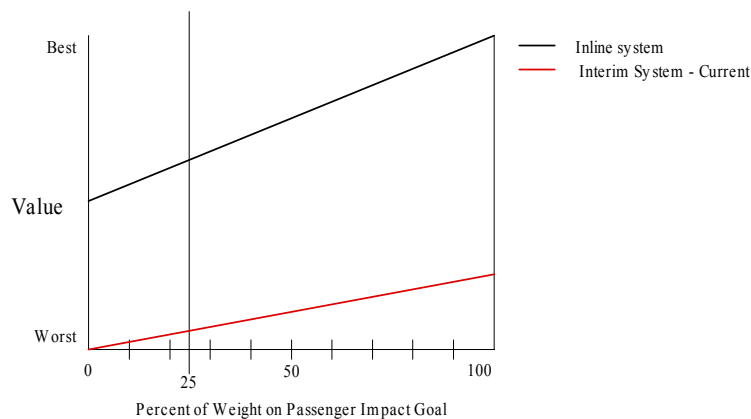

Figure 52: Passenger Impact Branch Sensitivity Analysis

4.4.2 Cost Hierarchy

Sensitivity analysis determined that that two of the three cost sub-objectives were insensitive to weight changes. Regardless of the change in weight for either the

Infrastructure or Acquisition objectives, the Terminal Floor System has the highest score. It was shown that the Personnel objective was sensitive to the change in weight. As shown in Figure 53, if there were questions on the Personnel weight, the decision will not change until the weight increases from its present value of 15% to 55% or higher. This would indicate insensitivity to the personnel weight, suggesting that short of a complete re-weighting, the Terminal Floor System will remain the preferred choice on cost (but not benefit).

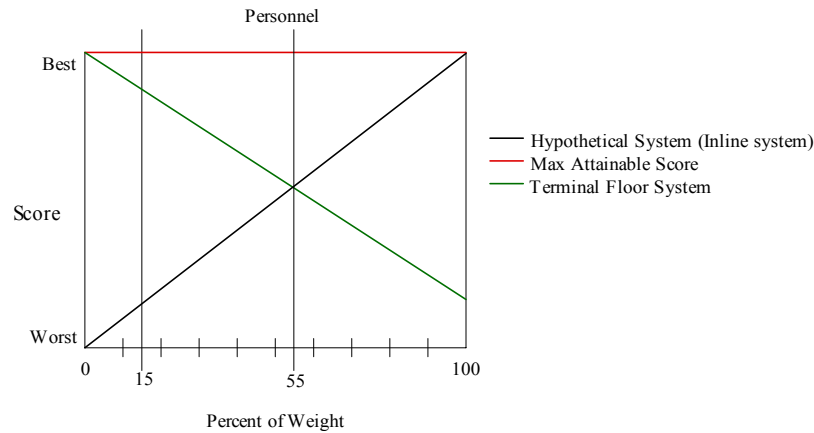

Figure 53: Personnel Sensitivity Analysis

Sensitivity Analysis was performed on each first tier objective of both hierarchies. The Analysis using the notional alternatives illustrated that the Hypothetical Inline System was insensitive to weights. Therefore regardless of the weighting used to weight the Checked Baggage System Hierarchy the rankings would not change. A similar conclusion can be drawn for the Sensitivity Analysis performed on the Cost Hierarchy except for the Terminal System alternative. The weights would have to be dramatically changed in order to change the alternative ranking for the Cost Hierarchy. Such an analysis helps focus where more detailed discussion of the weights may be required. In

the small, notional example, the decisions on benefit and cost are insensitive to the weighting.

Chapter 5. Findings & Conclusions

5.1 Overview

The Dayton International Airport, along with the rest of the commercial airports in the nation, was mandated to implement 100 percent screening of checked baggage with explosive detection systems by 31 December 2002. Prior to this mandate, the FAA goal for 100 percent checked baggage screening was 2009. A longer design process, with the involvement of the airport stakeholders, would be desirable to design and implement a solution that would best meet the security requirements while maximizing efficiency and minimizing any negative impacts to the stakeholders. The time was not available before implementing an interim solution. With the security requirements mitigated, Dayton International Airport has the time to evaluate potential long term solutions for a 100 percent checked baggage system. Value Focused Thinking was used to develop a value model to assist in the evaluation of potential checked baggage system alternatives. This methodology enabled the study group consisting of Dayton International Airport stakeholders to create a value model with the objectives they found to be most important for a 100 percent checked baggage system. The model developed will allow the airport to make decisions based on these objectives.

5.2 Value Model Strengths

The value hierarchy developed in this study was created by eliciting critical objectives of the Dayton International Airport stakeholders. The integrated study team, consisting of five key stakeholders from the Airport Operations Staff, Airlines, and TSA met on six different occasions as a group to develop 23 measures and value functions for a Checked Baggage System Hierarchy. The study team also developed 3 measures and value functions for a Cost Hierarchy. These stakeholders provided their valuable insight and expertise and ultimately spent more than 150 man-hours to complete the development of this model. This hierarchy can be used to assist the Dayton International Airport stakeholders in making a better informed and defensible decision that could ultimately lead to higher levels of efficiency and passenger convenience than currently provided by the airport's checked baggage system.

This is the first documented use of VFT to assist airports in the selection of potential long term solutions for 100 percent checked baggage systems.

5.3 Value Model Weaknesses

The value model requires some data not available during this research for to provide a more meaningful comparison of potential alternatives. These three measures do, however, suggest future data requirements for the TSA and others to consider. The study did not compare real world alternatives. The value functions used in this study were developed with deterministic or point estimates for the measure scores. These point estimates do not take into account the uncertainty and risk involved in decision making.

5.4 Conclusion

The research has shown that a value model could be developed to aid Dayton International Airport in evaluating potential long term solutions for a 100 percent checked baggage system. A hypothetical checked baggage system was developed that provided more value than the current checked baggage system in use at airport. The study provides insight about the value of the current system including the identification of value gaps where the current system could be improved.

5.5 Recommendations for Future Work

Follow up research could be conducted with Dayton International Airport to gather data and incorporate it into the model's measures and value functions. A model with complete data could provide additional insight into how to select the best 100 percent checked baggage system. The value model could be used to tailor requests for bid proposals to provide design packages for a checked baggage system. This decision aid could be modified and used as a decision aid for stakeholders from other airports within the United States faced with the same problem.

Appendix A: Local Weights by Branch

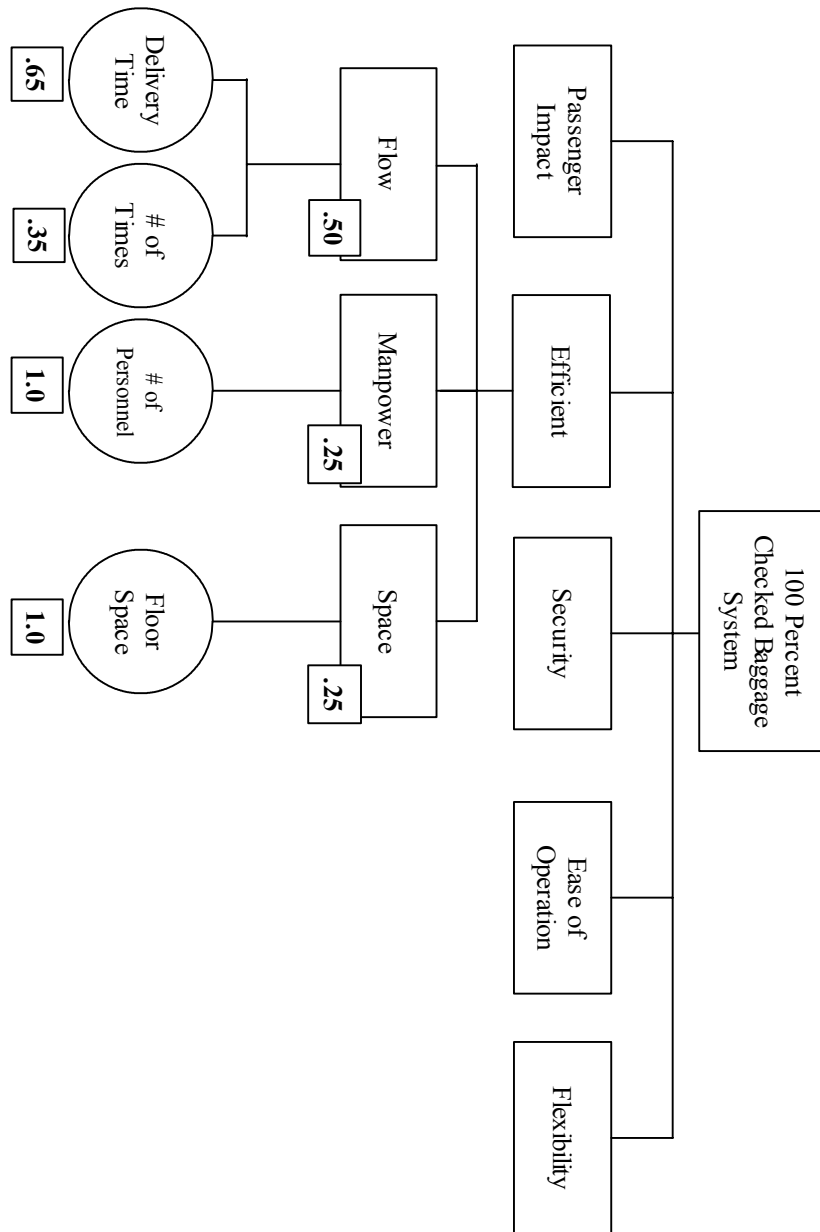

Figure A 1: Efficient Branch with Local Weights

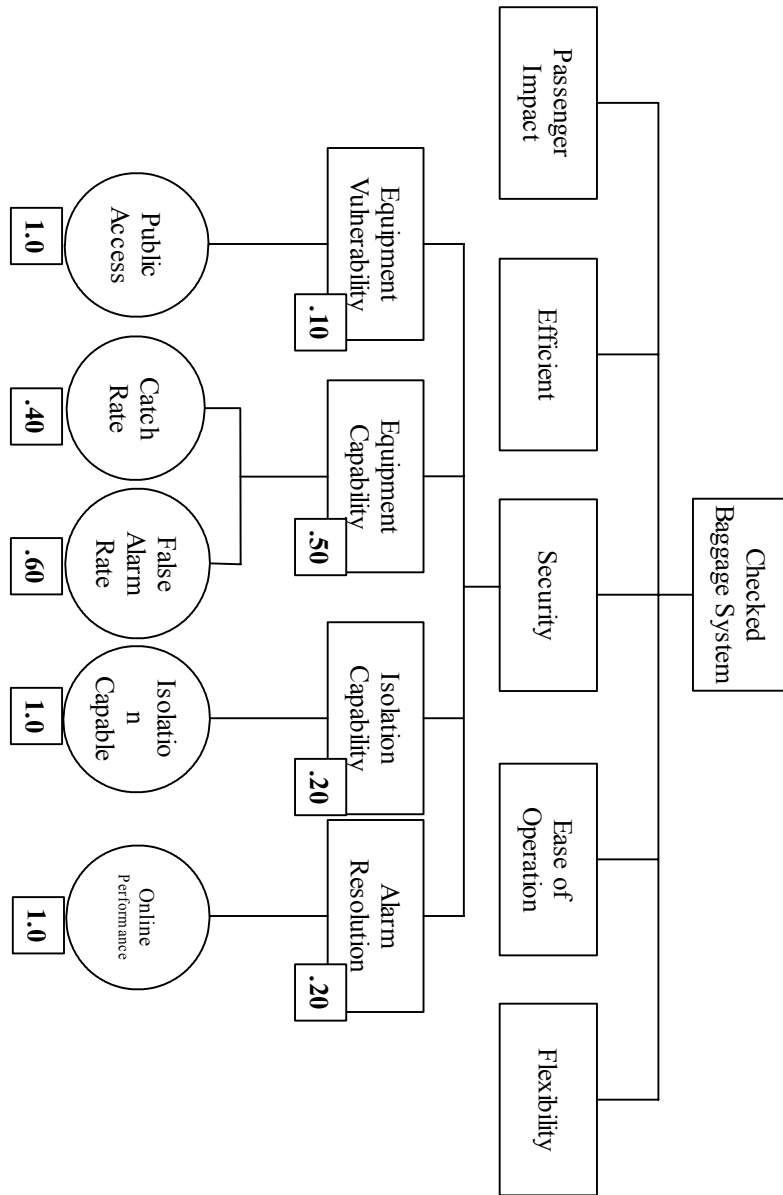

Figure A 2: Security Branch with Local Weights

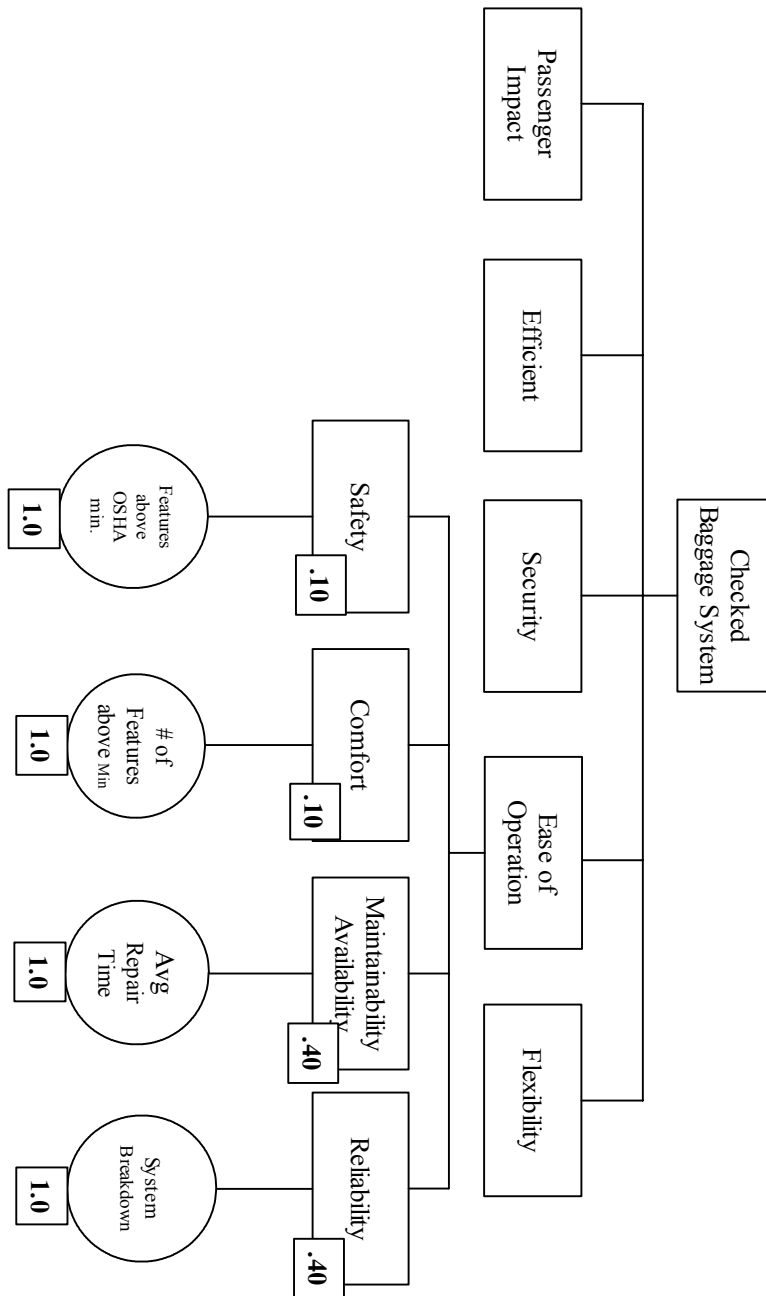

Figure A 3: Ease of Operation Branch with Local Weights

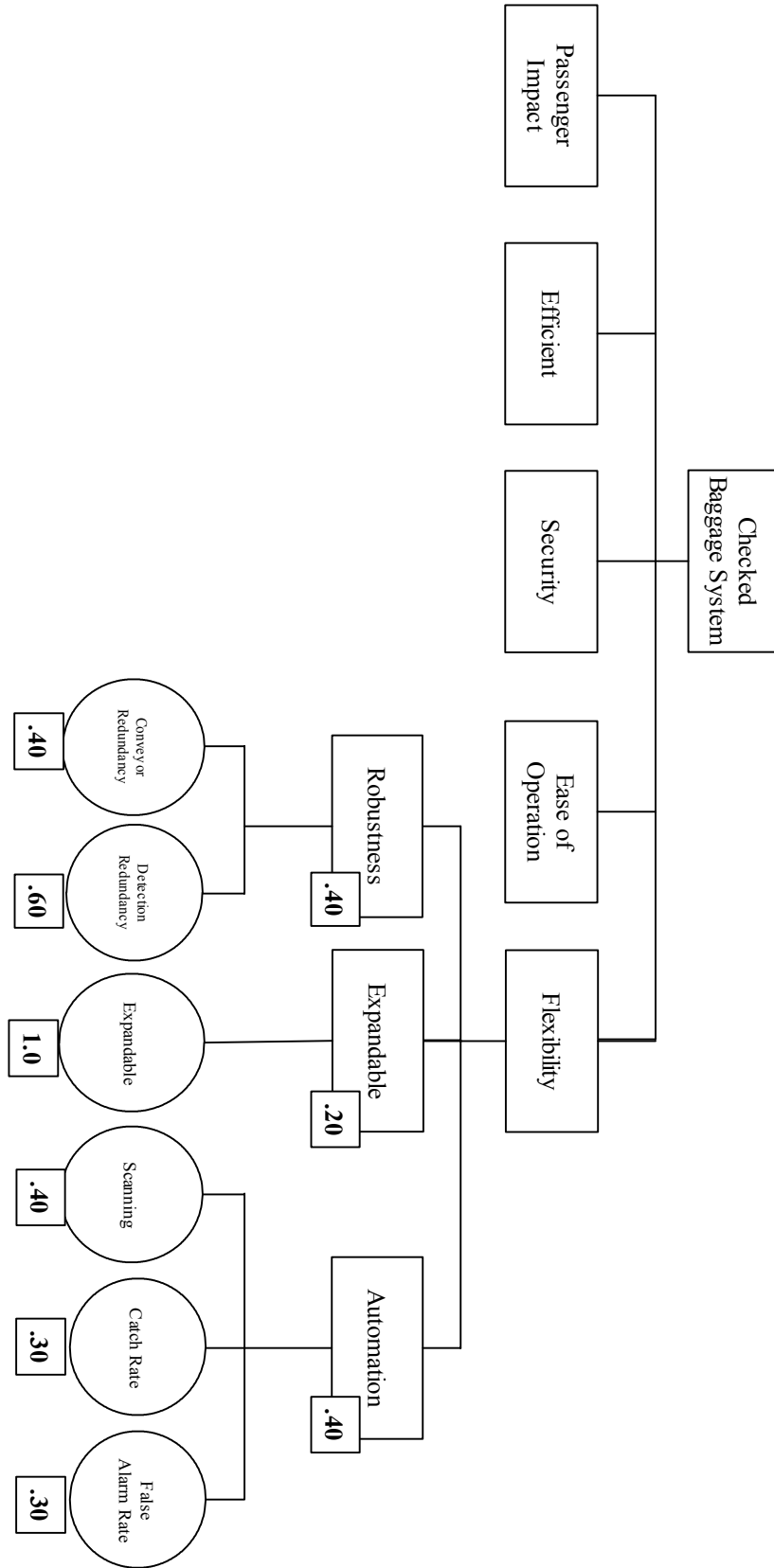

Figure A 4: Flexibility Branch with Local Weights

Appendix B: Integrated Study Team Minutes

AIR FORCE INSTITUTE OF TECHNOLOGY (AFIT) DAYTON INTERNATIONAL AIRPORT STAKEHOLDERS CHECKED BAGGAGE SYSTEM STUDY

INITIAL MEETING MINUTES 10 DEC 2002

TIME: 0900-1030

PLACE: Dayton International Airport Operations, 5th Floor Conference Room

ATTENDEES:

Capt Stephen Chambal, AFIT

Dr. Dick Deckro, AFIT

Capt Quincy Meade, AFIT

Mr. Jon Vrabel, Dayton International Airport, Operations

Mr. Doug Warner, Dayton International Airport, Facilities

Mr. Dave Mason, Dayton International Airport, Chief Engineer

Mr. Ronnie Wayne, Delta Airline Manager, Dayton International Airport

Mr. Bob Hall, Continental Airline Manager, Dayton International Airport

Mr. Youseff Elzein, Dayton International Airport, Senior Engineer

Mr. Jerry Witt, TSA, Dayton International Airport

Mr. Ray Muench, UNISYS, IT Engineer

PURPOSE:

Introduce Value Focused Thinking (VFT), a decision analysis methodology and an application of VFT for Dayton International Airport's long term solution for a 100% checked baggage system. Appoint team members from interested stakeholders for an integrated study team (IST). Set first meeting for IST to begin work on a value hierarchy.

OPENING DISCUSSION:

All attendees introduced themselves. Dr. Deckro provided an overview briefing on the VFT methodology. Capt Chambal discussed real world applications of VFT for a classified information system at the Air Force Technical Applications Center and the Air Force Force Protection Battlelab. Capt Meade introduced the focus of this study; Dayton International Airport's checked baggage system.

INTRODUCTION AND ACCOMPLISHMENTS:

All attendees were given an opportunity to ask questions about the VFT methodology and scope of the study for the Dayton International Airport's baggage system.

Ronnie Wayne expressed concern about human factors, focus on passengers, and providing options to an in-line system. Regardless of the system to be used there will be some level of human involvement. An example would be an employee at the end of the baggage system that becomes ill and as a result is unable to keep the system from backing up. The law requires the security measures but the airports are in place to serve the passengers (customers) and its imperative to keep them as satisfied as possible. The study should include the perceptions of the passengers. Additionally, the study shouldn't be limited to that of an in-line system but instead focus on the values important in a checked baggage system.

Jerry Witt asked if the group from AFIT had clearances to view classified and sensitive documents. Dr. Deckro stated that the AFIT members have security clearances at no less than the Secret level.

Bob Hall pointed out that the literature review references presented on slide 23 of the briefing did not include Title 49 CFR parts 1540 and 1544.

Youseff Elzein stated that this study should be complete prior to selecting the best layout for the checked baggage system. Several consultants are available to prepare alternatives and two have already been prepared.

Dave Mason stated that the timeline of the study and that of checked baggage system are separate. The set up of the checked baggage system will not be dependant upon the completion of this study. The results of the study can be used to aid in a long term solution of the airport's checked baggage system.

Ronnie Wayne asked about the possibility of one or more of the AFIT group to get a badge for unescorted access in the airport. After some discussion as to the time it normally takes to complete the paperwork, Capt Meade agreed to get a badge.

Members for the IST were appointed as follows:

IST members:

Capt Quincy Meade, Capt Stephen Chambal, Dick Deckro	AFIT
John Thomas, David Meek	TSA
Jon Vrabal, Youseff Elzein, Doug Warner	Dayton International Airport
Bob Hall	Continental
Ronnie Wayne	Delta

OPEN ITEMS:

The next meeting for the IST was not set at the meeting. All parties generally agreed that the best times for a meeting would be Tuesdays to Thursdays. Capt Meade is responsible for coordinating the next meeting date and time and will contact all parties. Capt Meade will arrange individual meetings with the IST members in advance of our first group meeting to be scheduled after 6 JAN 03.

**AIR FORCE INSTITUTE OF TECHNOLOGY (AFIT)
DAYTON INTERNATIONAL AIRPORT STAKEHOLDERS
CHECKED BAGGAGE SYSTEM STUDY**

INTEGRATED STUDY TEAM MEETING #2, 14 JAN 03

TIME: 1300-1600

PLACE: Dayton International Airport, Business Traveler Conference Room

ATTENDEES:

Capt Stephen Chambal, AFIT

Dr. Dick Deckro, AFIT

Capt Quincy Meade, AFIT

Mr. Jon Vrabel, Dayton International Airport, Operations

Mr. Youseff Elzein, Dayton International Airport, Senior Engineer

Mr. Dave Mason, Dayton International Airport, Chief Engineer

Mr. Doug Warner, Dayton International Airport, Facilities

Mr. Bob Hall, Continental Airline Manager, Dayton International Airport

PURPOSE:

Begin the development of the 100% checked baggage system value hierarchy. Complete the first tier of the hierarchy and continue breaking down first tier objectives.

OPENING DISCUSSION:

The minutes of the previous meeting were discussed. The research timeline was introduced with the following items.

Develop and Verify Hierarchy	14 JAN 03
Develop Measures	TBD
Weight Hierarchy	TBD
Score and Analyze Options	TBD

Dates were not provided at the time in order to arrange for another group meeting time that will accommodate all the team members. Wednesdays at 1pm appear to be the best time to meet as a complete group.

A first tier example for a 100% checked baggage system was provided to begin group discussion. The group then began building an affinity diagram to develop the value hierarchy.

ACCOMPLISHMENTS:

The first tier of the value hierarchy was developed by brainstorming the most important values to the group members. Each member of the study group provided the objectives most important to them in a 100 percent checked baggage system. Each item was recorded and then grouped into common headings using an Affinity diagram. These main headings became the first tier objectives. These first tier objectives are:

- Passenger Impact
- Efficiency
- Flexibility
- Security
- Reliability
- Cost

The Affinity Diagram inputs are as follows:

FLEXIBILITY

- Impact on airline staff
- Work within the environment
- Re-routing
- Personnel
- Location
- Back up
- Technology
- Shut down procedures
 - For breaks and hits
- Upgradeability
- Expandability
- Scalability
 - Operationally

The following was discussed for the first tier objective, Flexibility.

The impact on the airline staff is an issue. It's desirable to have a system that will not result in a requirement for airline personnel to handle problems associated with damaged, lost, or misrouted bags.

The system must work within the environment. The airport was designed and built prior to the requirement for the 100% checked baggage system. Therefore it's important that the long term solution is built in a manner that works within the Dayton airport facilities.

The system should have the capability to re-route bags should part of the system have a problem such as a conveyor belt jam or screening machine breakdown. The system should be able to re-route the bags so that the processing remains active.

The location of the system is important in that the needs of the airport are dynamic. The passenger flow among the airlines as well as the number of airlines will most likely change with time. This flexibility with respect to the location of the system should allow for these changes.

Back-up systems are important to keep the bag screening operation running even though one or more sub-systems may fail.

The technology of the explosive detection systems, trace detection, and other screening devices are improving over time. The system should be flexible with respect to the ability to replace and incorporate the latest approved technology.

Shut-down procedures need to be addressed within the system. This includes procedures to handle shut-downs caused from both a positive hit to an alarm and machine breakdowns. This is related to the back-up systems.

The system should be upgradeable. As discussed with the inevitable changes and improvement in technology the baggage screening system needs to allow for upgrades.

The system should be expandable. The number and sizes of the airlines could quite possibly increase and a system that allows for expansion to accommodate this increase is desired.

The system should be scalable to accommodate lower passenger loads and the difference in loads between the airlines. During off-peak times, lower staff numbers should be needed and the system should accommodate the change to the lower staff.

PASSENGER IMPACT

- Clarity of use
- Number of times handling the bag
- Visibility of bags
- Customer hassle
 - Queues, lines, time, overall time, least amount of changes, straight line from point A to B
- Passenger confidence
- Passenger convenience
- Visibility of security
- Integrated with check point

The following was discussed for the first tier objective, Passenger Impact.

A simple system that is as straight forward to the passenger as possible is most desirable.

The number of times the passenger is required to handle his/her bag should be limited as well as the distance that the passenger must hand carry them within the airport.

The combination of the number of times the passengers have to carry their bags along with the number of queues, and the additional distance involved in processing the passengers roll into the hassle factor.

The visibility of the bags is important in that the passenger can observe that the security measures are performed effectively.

The passenger should receive confidence that the system is providing them protection. Part of this confidence is created by the visibility of the security. That can be created through closed circuit television monitors, or presentation boards that display the routing and screening process.

The convenience to the passenger is important and that is affected by the amount of hassle they have to put up with.

The bag screening process should be integrated into the passenger screening checkpoint

EFFICIENCY

- Bottlenecks, logistical issues, don't forget these
- Flow efficiency/congestion at the end of the system
- Impact on airline staff
- Number of times airline handling bags
- Efficient, throughput
- Automated kick off for flagged bag
- Uninterrupted flow
- Space utilization
- Different run speeds
- Reaction to first hit
- Flow assurity – the bags to the right place

The following was discussed for the first tier objective Efficient

It's important that the system doesn't have bottlenecks that create backups, inefficient use of the screening machines, and delay to the bag process times.

The system should have an efficient flow that avoids congestion after the bags are screened. A build up of bags will create delays in the transfer of the bags to the planes and impact the airlines departure times.

The impact to the airline staff should be kept to a minimum and allow for accommodation for the various peak passenger flow times.

Handling of the bags by the airline staff will impact the number of airline personnel needed to handle passengers.

Utilization of the airport building space for the system is important. Building space was limited prior to the additional screening requirements and now it's even more important to avoid using more space than necessary.

The throughput of the bags should be done in an efficient manner. An automated kick off capability is important to allow for additional screening of flagged bags while not hindering the flow of the other bags.

The uninterrupted flow capability is important.

The bags ultimately need to get to their final destinations. Part of this issue is having a system that can maintain an accurate accountability/identification of baggage throughout the screening process.

SECURITY

- Security of equipment
- Vulnerability
- Visibility of equipment – mental benefit (moved to passenger confidence)
- Alarm resolution
- Isolation capability of a major hit/security breach

The following was discussed for the first tier objective Security

The vulnerability of the equipment is important. It's desirable to locate the screening system in an area with non-public access or the security identification display area (SIDA).

It's important that the system accommodates the various levels of alarm resolutions. (Not sure what else we were saying here?)

The isolation capability is desired to handle major hits/threats while allowing the remaining system and bag flow to continue.

RELIABILITY (need new name, broader, maybe suitability)

- Reliability, maintainability, availability stuff, RM&A
- Safety
- Exposure to radiation
- Comfort of screeners
- Environment of screeners

The following was discussed for the first tier objective Reliability

Reliability: It's important that the system is able to perform without breakdowns from machine failure or overburden by bag flow

Maintainability: The system should allow for trained personnel to perform routine work on it to keep it running as close to its original or new operating state.

Availability: It's important that the system be able operate when needed.

The safety to the personnel operating the screening systems is important. The system should be designed to allow for access to the system to resolve jams, maintain and operate equipment with the risk of injury kept to a minimum.

The environment and comfort of the screeners is important. It's important that the system has an environment which accommodates the shift durations of the operators. Uncomfortable work conditions for the system operators could result in improperly screened bags as well as slow process times.

Part of the safety issue is the protection of the screening machine operators from radiation exposure. The system should allow for the accurate monitoring and protection of the operators to avoid this danger.

COST (the airport is considered a money maker for the city and thus is operated in this manner, to max profit)

Personnel
Money
Infrastructure

Cost is viewed from the standpoint that the airport is a business and it's intended to make a profit. The staff required to maintain, operate, and resolve problems/issues created from the system is important. This staff includes those of the airlines, airport, and the TSA. The personnel will have both an annual and training requirement. The training required will be impacted by the complexity of the system for its operation and maintenance.

OPEN ITEMS:

The next meeting will begin with a review of the affinity diagram values. The bottom tiers of the value hierarchy including measures will be developed at the next meetings. Next week's meeting for the Integrated Study Team was tentatively set for Wednesday 22 JAN at 1pm. A group email with next meeting's agenda and location will be sent to all group members no later than Monday 20 Jan.

**AIR FORCE INSTITUTE OF TECHNOLOGY (AFIT)
DAYTON INTERNATIONAL AIRPORT STAKEHOLDERS
CHECKED BAGGAGE SYSTEM STUDY**

INTEGRATED STUDY TEAM MEETING #3, 22 JAN 03

TIME: 1300-1700

PLACE: Dayton International Airport, Airport Operations Conference Room

ATTENDEES:

Dr. Dick Deckro, AFIT

Capt Quincy Meade, AFIT

Mr. Youseff Elzein, Dayton International Airport, Senior Engineer

Mr. Ronnie Wayne, Delta Airline Manager, Dayton International Airport

Mr. Doug Warner, Dayton International Airport, Facilities

Mr. David Meek, Chief of Baggage Screeners, TSA

PURPOSE:

Continue with and finish the development of the 100% checked baggage system value hierarchy. Begin the development of measures.

OPENING DISCUSSION:

The minutes of the previous meeting were discussed. The research timeline was introduced with the following items.

Develop and Verify Hierarchy	14 / 22 JAN 03
Develop Measures	22 / 29 JAN 03
Weight Hierarchy	5 FEB 03
Score and Analyze Options	5 FEB 03

ACCOMPLISHMENTS:

The first tier objectives of the 100 percent checked baggage system hierarchy was decomposed down to sub-objectives that could be measured. The development of the hierarchy was completed during the meeting; measures were defined for the Security sub objectives. There was not time to finish the development of measures for the other branches.

The group reviewed the first tier of the hierarchy developed during the previous meeting. The first tier objectives were then addressed individually along with the associated sub-objectives groups introduced during the last meeting. The group decided to separate the costs from the original hierarchy and establish a separate hierarchy for cost.

The first tier objective Efficient was broken into three sub-objectives. They are flow, manpower, and space. Flow is the value for a fast through put of the checked bags, free of congestion, uninterrupted between check in and the end of the screening. This flow also includes the need for assurance that the bags are getting to the right place. Manpower is the value to limit the amount of personnel needed for handling and screening. Space is the value to avoid congestion.

The first tier objective for Security was broken down into five sub objectives. They are Equipment Vulnerability, Equipment Capability, Isolation Capability, Alarm Resolution, and Manpower Impact. Equipment Vulnerability is the value of having a system that is closed off from public access. Equipment Capability is the ability of a screening system to detect explosives, the speed of processing bags and the reliability that the system will be available. Isolation Capability is the ability of the system to separate a bag from the flow of bags so as not to impede bag processing. Alarm Resolution is the ability of the explosives detection equipment to assist operators in resolving alarms (alert by screening machine that a threat has been detected.) The Manpower Impact is the value to limit the personnel needed to maintain, operate, and resolve issues that result from the use of the checked bag system.

The first tier objective for Ease of Operation was broken down into five sub objectives. They are Safety, Comfort, Maintainability, Availability, and Reliability.

The first tier objective for Flexibility was broken down into three sub objectives. They are Robustness, Expandable, and Automation.

The first tier objective for Cost was broken down into three sub objectives. They are People, Infrastructure, and Acquisition.

The group focused on the Security tier and began to develop measures. These measures were developed as follows:

Equipment Vulnerability: Yes/No for Public Access. If the system is located in a Security Identification Display Area then the value is 1.0. If the public does have access then the value is 0.

Equipment Capability: Two measures were developed, Catch Rate and False Alarm Rate.

Isolation Capability: Yes/No for Isolation Capable. If the system is capable of isolated bags such as the latest screening machines from Invision then the value is 1.0, if the system is not capable of isolating the bags then the value is 0.

Need to develop measures for these two sub objectives.

Alarm Resolution and Manpower Impact.

OPEN ITEMS:

The measures need to be developed for remaining lowest tier sub-objectives for the other branches of the 100 percent checked baggage and cost hierarchies. Next week's meeting for the Integrated Study Team was tentatively set for Wednesday 29 JAN at 1pm.

**AIR FORCE INSTITUTE OF TECHNOLOGY (AFIT)
DAYTON INTERNATIONAL AIRPORT STAKEHOLDERS
CHECKED BAGGAGE SYSTEM STUDY**

INTEGRATED STUDY TEAM MEETING #4, 29 JAN 03

TIME: 1300-1600

PLACE: Dayton International Airport, Airport Operations 5th Floor Conference Room

ATTENDEES:

Capt Stephen Chambal, AFIT

Dr. Dick Deckro, AFIT

Capt Quincy Meade, AFIT

Mr. Youseff Elzein, Dayton International Airport, Senior Engineer

Mr. Ronnie Wayne, Delta Airline Manager, Dayton International Airport

Mr. Bob Hall, Continental Airline Manager, Dayton International Airport

Mr. David Meek, TSA DAY

PURPOSE:

Continue with the development of the 100% checked baggage system value hierarchy. Review those measures already proposed and develop measures for those sub-objectives not addressed yet.

OPENING DISCUSSION:

The 100% checked baggage system value hierarchy developed from the last meeting on 22 Jan 03 was provided to begin the review. Each first tier objective of this hierarchy was reviewed briefly along with their corresponding sub-objectives and measures. The group then continued to develop measures.

ACCOMPLISHMENTS:

Updates to the hierarchy are described below under their first tier objective.

SECURITY:

The security objective from the last meeting had five sub-objectives. Measures were developed for those sub-objectives as follows:

Equipment Vulnerability:

The value for equipment vulnerability is measured by whether the system is in a public access area of the airport or a Security Identification Display Area (SIDA). A value of 1 is given to a system that is not accessible by the public. A value of 0 is given to a system that is accessible to the public.

Equipment Capability:

The value for equipment capability is measured by the system's average detection rate and false alarm rates. The detection rate is the percentage of threats correctly identified based on red team inspections. The detection rate measure has an x-axis that ranges from the minimum acceptable detection rate to 100% detection. The minimum acceptable detection rate may be as high as 90% in that case the x axis would only cover a range of 10% (Difference between 90% detection and perfect 100%). The corresponding y-axis ranges from 0 to 1 (representing the value). The minimum detection has a value of 0 while the 100% detection has a value of 1. The group decided that at 95% of the gap the corresponding value would be 0.66. The value will increase in a positive exponential manner as shown in the figure below.

False Alarm Rate

The false alarm rate is the number of bags that are incorrectly identified with threats divided by the total number of bags screened. The most preferred false alarm rate is 0% and is given a value of 1.0. The least preferred false alarm rate is 40 %. The 40% is used as a 'best guess' to current minimum performance of initial alarms that are resolved and found to be false alarms.

Isolation Capability:

The value for isolation capability is measured by whether the system is capable of isolating bags that have shown positive. The isolation capability is desired and if the system has this capability the value is 1.0. If it's not isolation capable then the value is 0.

Alarm Resolution:

The value for alarm resolution is measured by the percentage of alarms that are able to be resolved without removing the bags from the screening machines. The value for alarm resolution increases in an exponential manner as the percentage of threats resolved increases. A value of 0.5 is obtained for a system that resolves 30% of the alarms. A value of 0.9 is obtained from a system that is able to resolve 90% of the alarms.

Manpower Impact: This sub-objective was removed from Security and will be addressed within the Cost Hierarchy.

PASSENGER IMPACT:

The Passenger Impact objective is broken down into confidence and convenience.

The study group decided to define the confidence sub-objective down into communicate security which is defined by whether the system allows the passenger to see the bag screening and routing operation. This can be accomplished through either a closed circuit television, windows that allow the customers to see the operation, or a display that illustrates the route and screening measures in place at the airport.

Visible System:

If the bag screening system has one of the three methods in place to communicate the security then the value is 1.0. If the system is not visible and hidden from the passenger then that is given a value of 0.

The convenience part of the passenger impact is broken down into sub-objectives for handling bags and time.

Distance

The distance that the passenger has to move checked bag in screening process It is preferred to have a system that will not require the passengers to move their bags at all after checking them in at the airline ticket counter. A system that requires passengers to move their bags 100 feet or more receives a value of 0.0. A system that does not require passengers to move their bags after check in receives a value of 1.0.

Times Handled

The number of times the passenger has to move checked bag from one screening station to another before screeners take custody of the bag. Having to move bags a number of different times between security stations is considered an inconvenience as was the distance required to move the bags. Not handling the bags at all after tagging receives a value of 1.0. Handling them once receives a value of 0.5 and handling them more than once receives a value of 0.0.

Time in Line

While the group felt passengers do understand and appreciate the need for security, their patience is not unlimited. Not waiting with the bags at all is the most preferred and receives a value of 1.0. For each minute the passenger waits the value decreases linearly up to 15 minutes or more when the value is 0.0

EFFICIENT:

The group divided the first tier objective Efficient into three sub-objectives. These are Flow, Manpower, and Space. Flow is measured by both time it takes on average for the bags to complete its movement through the system as well as how the bags are delivered to the Airlines baggage handlers.

Flow

The flow is further defined by the time the bags take to be processed from the point of being tagged by the airline ticket personnel and reaching the make up room. The bag delivery method is also used to define flow.

Time

Throughput of the baggage with emphasis to avoid congestion, bottlenecks, and interruption.

Bag Delivery Method

The greatest value for the baggage delivery method is from a system that sends screened bags to separate baggage handling areas for each airline. This method receives a value of 1.0. The second most preferential delivery setting is for a common make-up room for all airlines but with sorted areas for each airline's bags. This method receives a value of 0.8. The least preferred delivery method is for all bags to be delivered to a common make up room and not sorted by airline. This method receives a value of 0.0.

Manpower

Personnel fluctuations necessary to accommodate the varying passenger load. The manpower sub-objective value is measured by the fluctuation in number of operators necessary to support the system. No fluctuation is most preferred and receives a value of 1.0. A system that requires minor fluctuations in personnel levels is the second most preferred, receiving a value of 0.8. Minor fluctuations are variations of ten percent or less. A system that requires major fluctuation in personnel is the least preferred and receives a value of 0.0. Major fluctuations are personnel variations of more than 10 percent.

Space

The value for the space sub-objective is measured by whether additional floor space will be needed to be constructed to support the operation. It is most preferred to have a system that requires no terminal floor space; such a system would receive a value of 1.0. The second most preferred system would take up no more floor space than currently available to conduct baggage screening in the lobby area without changing the existing floor layout. That system would receive a value of 0.5. The least preferred system would require more floor space than is currently used and that system would receive a value of 0.0

At this point the group ended the meeting

OPEN ITEMS:

In an effort to make an efficient use of the next meeting it was suggested to send out a request for input on the remaining measures. The Ease of Operation and Flexibility branches haven't had measures developed for their lowest tier sub-objective.

All members of the study group have been asked to forward any recommendations on the remaining objectives that need to have measures developed to Capt Meade. In addition, any questions on the objectives and measures already developed should also be sent.

**AIR FORCE INSTITUTE OF TECHNOLOGY (AFIT)
DAYTON INTERNATIONAL AIRPORT STAKEHOLDERS
CHECKED BAGGAGE SYSTEM STUDY**

INTEGRATED STUDY TEAM MEETING #5, 05 FEB 03

TIME: 1300-1600

PLACE: Dayton International Airport, Airport Operations 5th Floor Conference Room

ATTENDEES:

Capt Stephen Chambal, AFIT

Dr. Dick Deckro, AFIT

Capt Quincy Meade, AFIT

Mr. Youseff Elzein, Dayton International Airport, Senior Engineer

Mr. Ronnie Wayne, Delta Airline Manager, Dayton International Airport

Mr. Jon Vrabel, Dayton International Airport, Operations

PURPOSE:

The development of the 100 percent checked baggage system value hierarchy has been completed. Measures were also developed for several of the lowest tier sub-objectives. Measures will be developed during this meeting for the Ease of Operation and Flexibility branches of the 100 percent checked baggage system value hierarchy and the cost hierarchy.

OPENING DISCUSSION:

The cost objectives were removed from the 100 percent checked baggage system hierarchy. These cost objectives will be used for a separate cost hierarchy. The group started with the 100 percent checked baggage system hierarchy and finished development of the measures. The group then moved to the Cost hierarchy and finished development of all measures.

ACCOMPLISHMENTS:

Updates to the hierarchy are described below under their first tier objective.

EASE OF OPERATION:

The safety and comfort for the operators of the baggage screening system along with the maintainability, availability, and reliability

Safety

Number of features above Minimum Required, Safety. Example of feature includes a conveyor shut down switches that isolates portion of the baggage systems while allowing

other parts of the conveyor to continue operating. Each feature above zero receives a value increment of 0.2. Five or more features receives a value of 1.0

Comfort

Number of Features above Minimum Required, Comfort. Example includes item such as screening system monitors with reduced glare to reduce eye strain and will lead to more attentive operators. Each feature above zero receives a value increment of 0.2. Five or more features receives a value of 1.0

Maintainability / Availability

The average time for repairs to the system. A repair that takes more than 24 hours is considered unacceptable and would receive a value of 0.0. The most preferred repair time of 1 hour or less receives a value of 1.0. A repair time of 1 to 8 hours receives a value of 0.5. A system that has average repairs of 8 to 24 hours receives a value of 0.2.

Reliability

The number of breakdowns between normally scheduled maintenance downtime is the measure for reliability. A system that averages no breakdowns within the maintenance cycle receives a value of 1.0. A system with 3 or more breakdowns on average per month is considered unacceptable and receives a value of 0.0. A system that has an average of one breakdown receives a value of 0.5. A system that has an average of two breakdowns receives a value of 0.2.

FLEXIBILITY

The capability of adapting to new, different, or changing requirements

Conveyor Redundancy

Measure is how many back up measures are available on the conveyor system in case of a conveyor breakdown. The most preferred realistic number of redundant conveyor system is 3 or more for the Dayton International Airport. This system receives a value of 1.0. The least preferred option is for the checked baggage system to have no redundant conveyor systems. This system receives a value of 0.0.

Detection Redundancy

Measure is how many back up detection systems are available to screen bags identified as threats. A system that has 3 or more redundant detection features is most preferred and receives a value of 1.0. The least preferred option is for the checked baggage system to have no redundant detection systems. This system receives a value of 0.0.

Expandable

It is most preferred to have a checked baggage system that can be expanded to take on a larger passenger load accommodating any expansion in passenger loads and air carriers. This is a yes/no measure. If the system can be expanded it receives a value of 1.0. If it can not be expanded, it receives a value of 0.0.

Automation

Tracking

It is preferred to have a checked baggage system that is capable of tracking bags in the screening process and can tell where a checked bag is located. This like the expandable measure, is a yes no measure. A system that automatically tracks checked bags gets a value of 1.0 and a system that is not capable of tracking automatically gets a 0.0

Routing Divert

The study group prefers a checked baggage system is capable of automatically routing and diverting bags. Such automated handling reduces personnel needs and, when properly implemented, provides better service than manual handling. If the system can automatically route and divert is gets a value of 1.0 and if it can not it gets a value of 0.0

Sort to Airline Make-up room

If the system is capable of automatically sorting bags to airline make up rooms it gets a value of 1.0 if not it gets a value of 0.0.

COST

People

The personnel necessary to operate the system. The most preferred number of operators is 3 which receive a value of 1.0. The least preferred is 10 or more operators which receives a value of 0. The value decreases linearly as the number of operators increases from 3 to 10.

Infrastructure

The level of construction necessary to install the system. A system that can be installed without construction to the facility is most preferred and receives a value of 1.0. A system that requires minor work receives a value of 0.5 and major work gets a value of 0.0.

Acquisition

The purchases made for a system which includes conveyor systems, display monitors. A system that will not incur any cost to the Airport for these items is the most preferred and receives a value of 1.0. A system that requires 1.5 Million dollars (NPV) or more is the least preferred and receives a value of 0.0. As the cost for these items moves from zero dollars to 1.5 Million dollars (NPV) the value decreases linearly

OPEN ITEMS:

Both hierarchies need to be given weights by the decision maker. The next meeting will include Jon Vrabel and Youseff Elzein, who will weigh the hierarchies on behalf of Mr. Eugene Conrad.

**AIR FORCE INSTITUTE OF TECHNOLOGY (AFIT)
DAYTON INTERNATIONAL AIRPORT STAKEHOLDERS
CHECKED BAGGAGE SYSTEM STUDY**

INTEGRATED STUDY TEAM MEETING #6, 14 FEB 03

TIME: 1000-1200

PLACE: Dayton International Airport, Airport Operations 5th Floor Conference Room

ATTENDEES:

Capt Quincy Meade, AFIT

Mr. Youseff Elzein, Dayton International Airport, Senior Engineer

Mr. Jon Vrabel, Dayton International Airport, Operations

PURPOSE:

Weight both the 100% checked baggage system value hierarchy and cost hierarchy.

OPENING DISCUSSION:

The hierarchy objectives were reviewed. This was brief, as both Jon and Youseff took part in each phase of the value model development and were already familiar with the model. The 100 marble method was then used to provide direct weighting to each objective and measure of the hierarchy.

ACCOMPLISHMENTS:

Capt Meade recorded the local weights as provided by Jon Vrabel and Youseff Elzein. These weights would be converted to global weights and input into the Logical Decisions for Windows software to analyze two notional alternatives.

The Passenger Impact and Flexibility tier objectives received 0.25 of the weight each. They were deemed the most important to the Director of Aviation. The Ease of Operation objective was given a weight of 0.20. The Efficient objective was given a weight of 0.17. The Security objective was given a weight of 0.13. Security was given the least weight but this is not because security is not important. The security objectives provide value to capabilities above and beyond the minimum accepted criteria of the FAA and TSA. These minimum accepted standards are considered stringent. Therefore the other objectives were given more weight. The Passenger Impact and Flexibility objectives were given the most weight because they were seen as the most important to the passengers and the ability to accommodate various passenger loads. The Ease of Operation objective was given more weight than the Efficient objective because the standards for the workers were deemed as more important than the Efficient objectives.

Potential 100 percent checked baggage system alternatives were discussed. It was decided to use the current Terminal Floor system as well as a notional Inline system. The inline system would be integrated into a checked baggage system. Capt Meade would use the preferences identified by the study group for the notional inline baggage screening system.

Bibliography

- United States Congress. *Airport Security Improvement Act of 2000*, Public Law 106-528, 106th Congress, 2nd Session. Washington GPO 2000.
- National Material Advisory Board. *Assessment of Technologies Deployed to Improve Aviation Security: 1st Report*. Publication NMAB 482-5. National Academies Press , 1999.
- National Material Advisory Board. *Assessment of Technologies Deployed to Improve Aviation Security: Second Report: Progress Toward Objectives*. Publication NMAB 503. National Academies Press , 2002.
- National Material Advisory Board. *Configuration Management and Performance Verification of Explosive Detection Systems*. Publication NMAB 482-3. National Academies Press, 1998.
- General Accounting Office. *Aviation Safety and Security: Challenges to Implementing the Recommendations of the White House Commission on Aviation Safety and Security*. GAO/T-RCED-97-90. Washington: GPO, 1997.
- General Accounting Office. *Aviation Security: Commercially Available Advanced Explosives Detection Devices*. GAO/RCED-97-119R. Washington: GPO, 1997.
- General Accounting Office. *Aviation Security: FAA's Actions to Study Responsibilities for Airport Security and to Certify Screening Companies*. GAO/RCED-99-53. Washington: GPO, 1999.
- General Accounting Office. *Aviation Security: FAA's Procurement of Explosives Detection Devices*. GAO/RCED-97-111R. Washington: GPO, 1997.
- General Accounting Office. *Aviation Security: Immediate Action Needed to Improve Security*. GAO/T-RCED/NSIAD-96-237. Washington: GPO, 1996.
- General Accounting Office. *Aviation Security: Implementation of Recommendations Is Under Way, but Completion Will Take Several Years*. GAO/RCED-98-102. Washington: GPO, 1988.
- General Accounting Office. *Aviation Security: Progress Being Made, but Long-Term Attention Is Needed*. GAO/T-RCED 98-190. Washington: GPO, 1988.
- General Accounting Office. *Aviation Security: Slow Progress in Addressing Long-Standing Screener Performance Problems*. GAO/T-RCED-00-125. Washington: GPO, 2000.

- General Accounting Office. *Aviation Security: Technology's Role in Addressing Vulnerabilities*. GAO/T-RCED/NSIAD-96-262. Washington: GPO, 1996.
- General Accounting Office. *Aviation Security: Transportation Security Administration Faces Immediate and Long Term Challenges*. GAO-02-971T. Washington: GPO, 1997.
- General Accounting Office. *Aviation Security: Urgent Issues Need to Be Addressed*. GAO/T-RCED/NSIAD-96-251. Washington: GPO, 1996.
- General Accounting Office. *Aviation Safety: Weaknesses in Inspection and Enforcement Limit FAA in Identifying and Responding to Risks*. GAP/RCED-98-6. Washington: GPO, 1998.
- Butler, Viggo and Poole W. Robert. *Rethinking Checked-Baggage Screening*, Policy Study 297. July 2002. Los Angeles CA.
- Clemen, Robert T, and Reilly, Terrence *Making Hard Decisions with Decision Tools 2nd Edition*. Belmont CA: Duxbury Press, 1996.
- Transportation Research Board. *Deterrence, Protection, and Preparation: The New Transportation Security Imperative*. Special Report 270. National Academies Press, 2002.
- White House Commission on Aviation Safety and Security Final Report, February 12, 1997.
- Hamill, Jonathan T., *Modeling Information Assurance: A Value Focused Thinking Approach*, School of Systems and Engineering Management, Air Force Institute of Technology (AU), Wright Patterson AFB OH, Mar 2002.
- Jackson, Jack A., Jones, Brian L., Lehmkuhl, Lee J. *2025 Operational Analysis* 1996.
- Jurk, David M. *Decision Analysis with Value-Focused Thinking as a Methodology to Select Force Protection Initiatives for Evaluation*, School of Systems and Engineering Management, Air Force Institute of Technology (AU), Wright Patterson AFB OH, Mar 2002.
- Kauvar, Gary, Rostker, Bernard, Shaver, Russell *Safer Skies Baggage Screening and Beyond with Supporting Analysis*, RAND 2002.
- Keeney, Ralph L. *Value-Focused Thinking: A Path to Creative Decisionmaking*." Cambridge: Harvard University Press, 1992.

- Kirkwood, Craig W. *Strategic Decision Making: Multicriteria Decision Analysis with Spreadsheets*. Belmont: Wadsworth Publishing Company, 1997.
- Kloeber, Jack M. Class Lecture, OPER 745, Multiple Objective Decision Analysis. Graduate School of Engineering and Management, Air Force Institute of Technology, Wright Patterson AFB OH, Summer 2000.
- Lazarick, Richard and Cammaroto, Robert Recommended Security Guidelines for Airport Planning, Design and Construction DOT/FAA/AR-00/52 2001.
- National Research Council. *Making the Nation Safer: The Role of Science and Technology in Countering Terrorism*. Washington: National Academies Press, 2002.
- Parnell, G., Conley, H., Jackson, J., Lehmkuhl, L, and Andrew, J.,”Foundations 2025: A Framework for Evaluating Future Air and Space Forces,” *Management Science*, 1998, Vol 44, No 10, 1998,pp 1336-1350.
- Public Law 107-71 Aviation and Transportation Security Act, 19 November 2001.
- Shoviak, Mark J., *Decision Analysis Methodology to Evaluate Integrated Solid Waste Management Alternatives For a Remote Alaskan Air Station..* School of Systems and Engineering Management, Air Force Institute of Technology (AU), Wright Patterson AFB OH, Mar 2001.
- Sweet, Kathleen M. *Terrorism and Airport Security*, Symposium Series Vol 68, The Edwin Mellin Press, 2002.

Vita

Captain Quincy Meade graduated from Parry McCluer High School in Buena Vista, Virginia. He attended Virginia Military Institute in Lexington, Virginia where he graduated with a Bachelor of Science degree in Civil Engineering in 1995. He was commissioned through the Reserve Officer Training Corps in May of 1995.

His first assignment was to the 78 Civil Engineering Group at Robins AFB, GA. While at Robins AFB, he served as a civil design engineer, maintenance engineer, and as the Chief of the Simplified Acquisition of Base Engineering Requirements (SABER) flight.

In August of 1998, he was assigned to the 45th Civil Engineer Squadron, Patrick AFB, FL where he served as the Chief of the Delta Program within the Engineering flight at Cape Canaveral Air Force Station. While stationed at Patrick AFB he deployed in August of 1999 for three months to Ali Al Salem Air Base Kuwait and served as the Base Civil Engineer. In September of 2000 he deployed to Micronesia for eight months leading a 13 person Civic Action Team performing humanitarian construction projects and providing a medical and vocational apprentice training program on the remote island of Pohnpei.

In August of 2001 he entered the Graduate School of Engineering and Management, Air Force Institute of Technology. Upon graduation, Captain Meade will join the Headquarters Air Education and Training Command Civil Engineer's Staff at Randolph, AFB, TX.

REPORT DOCUMENTATION PAGE

Form Approved
OMB No. 074-0188

The public reporting burden for this collection of information is estimated to average 1 hour per response, including the time for reviewing instructions, searching existing data sources, gathering and maintaining the data needed, and completing and reviewing the collection of information. Send comments regarding this burden estimate or any other aspect of the collection of information, including suggestions for reducing this burden to Department of Defense, Washington Headquarters Services, Directorate for Information Operations and Reports (0704-0188), 1215 Jefferson Davis Highway, Suite 1204, Arlington, VA 22202-4302. Respondents should be aware that notwithstanding any other provision of law, no person shall be subject to a penalty for failing to comply with a collection of information if it does not display a currently valid OMB control number.

PLEASE DO NOT RETURN YOUR FORM TO THE ABOVE ADDRESS.

1. REPORT DATE (DD-MM-YYYY) 03-25-2003		2. REPORT TYPE Master's Thesis		3. DATES COVERED (From - To) Nov 2002 - Mar 2003	
4. TITLE AND SUBTITLE LONG TERM IMPLEMENTATION OF A 100 PERCENT CHECKED BAGGAGE SCREENING SYSTEM: A VALUE FOCUSED THINKING APPROACH				5a. CONTRACT NUMBER	
				5b. GRANT NUMBER	
				5c. PROGRAM ELEMENT NUMBER	
6. AUTHOR(S) Meade, Quincy, Captain, USAF				5d. PROJECT NUMBER	
				5e. TASK NUMBER	
				5f. WORK UNIT NUMBER	
7. PERFORMING ORGANIZATION NAMES(S) AND ADDRESS(S) Air Force Institute of Technology Graduate School of Engineering and Management (AFIT/EN) 2950 Hobson Street, Building 642, WPAFB OH 45433-7765				8. PERFORMING ORGANIZATION REPORT NUMBER AFIT/GEE/ENS/03-02	
9. SPONSORING/MONITORING AGENCY NAME(S) AND ADDRESS(ES) Dayton International Airport Attn: Mr. Eugene B. Conrad 3600 Terminal Drive, Suite 300 Vandalia, OH45377				10. SPONSOR/MONITOR'S ACRONYM(S)	
				11. SPONSOR/MONITOR'S REPORT NUMBER(S)	
12. DISTRIBUTION/AVAILABILITY STATEMENT APPROVED FOR PUBLIC RELEASE; DISTRIBUTION UNLIMITED.					
13. SUPPLEMENTARY NOTES					
14. ABSTRACT The terrorist attacks of 11 September 2001, carried out via aircraft hijackings, clearly demonstrated the massive destruction potential when vulnerabilities in the aviation system are exploited. Airport security measures have since been strengthened and new measures have been set in place. With the passage of the Aviation Security and Transportation Act of 2001 the checked baggage systems at U.S. Airports are now required to screen all checked bags with explosive detection devices. This is a significant increase from the small percentage of bags that were previously screened. Rather than allowing for the long term, phased planning that the original 2009 date would have provided, the requirement to screen all checked bags by 31 December 2002 forced airports to implement interim screening systems which can impact the efficient processing of passengers and baggage. A long term solution is needed for a 100 percent checked baggage system that provides the required security while minimizing negative impacts to aviation stakeholders including the airport operators, airlines, passengers, and the Transportation Security Administration. This thesis, focusing on Dayton International Airport, uses a Value Focused Thinking methodology to build a value model for evaluating potential long term solutions for 100 percent checked baggage system alternatives.					
15. SUBJECT TERMS Aviation Security, Baggage Screening, Security, Value Focused Thinking, Decision Analysis					
16. SECURITY CLASSIFICATION OF:			17. LIMITATION OF ABSTRACT	18. NUMBER OF PAGES	19a. NAME OF RESPONSIBLE PERSON Stephen P. Chambal, Capt, USAF (ENS)
a. REPORT	b. ABSTRACT	c. THIS PAGE			19b. TELEPHONE NUMBER (Include area code) (937) 255-6565, ext 4314; e-mail: Stephen.Chambal@afit.edu
U	U	U	UU	121	

Standard Form 298 (Rev. 8-98)
Prescribed by ANSI Std. Z39-18